

***Nikon***

**FTN2**

INSTRUCTION MANUAL

# NOMENCLATURE

① Shutter speed/mode selector locking button

Shutter speed/mode selector dial 19

② Shutter release button

Aperture direct readout (ADR) window 20

③ Shutter release fingerguard

Film rewind knob 21

④ Neckstrap eyelet

Sync terminal (cover provided) 22

⑤ Depth-of-field preview lever

Lens mounting index 23

⑥ Self timer/memory lock lever

Lens release button 24

⑦ Lens mounting flange

Meter coupling lever 25

⑧ Focusing screen holder release latch

Reflex mirror 26

⑨ Viewfinder ready-light

Film advance lever 27

⑩ Exposure compensation dial lock

Film sprockets 28

⑪ ASA/ISO film speed ring

Serial number 29

⑫ Viewfinder eyepiece

Film takeup spool 30

⑬ Rewind fork

⑭ Shutter curtains

⑮ Film cartridge chamber

⑯ Film guide pin

⑰ Film guide rails

Film anti-curl roller 31

⑱ Data back contacts

Locking catch 32

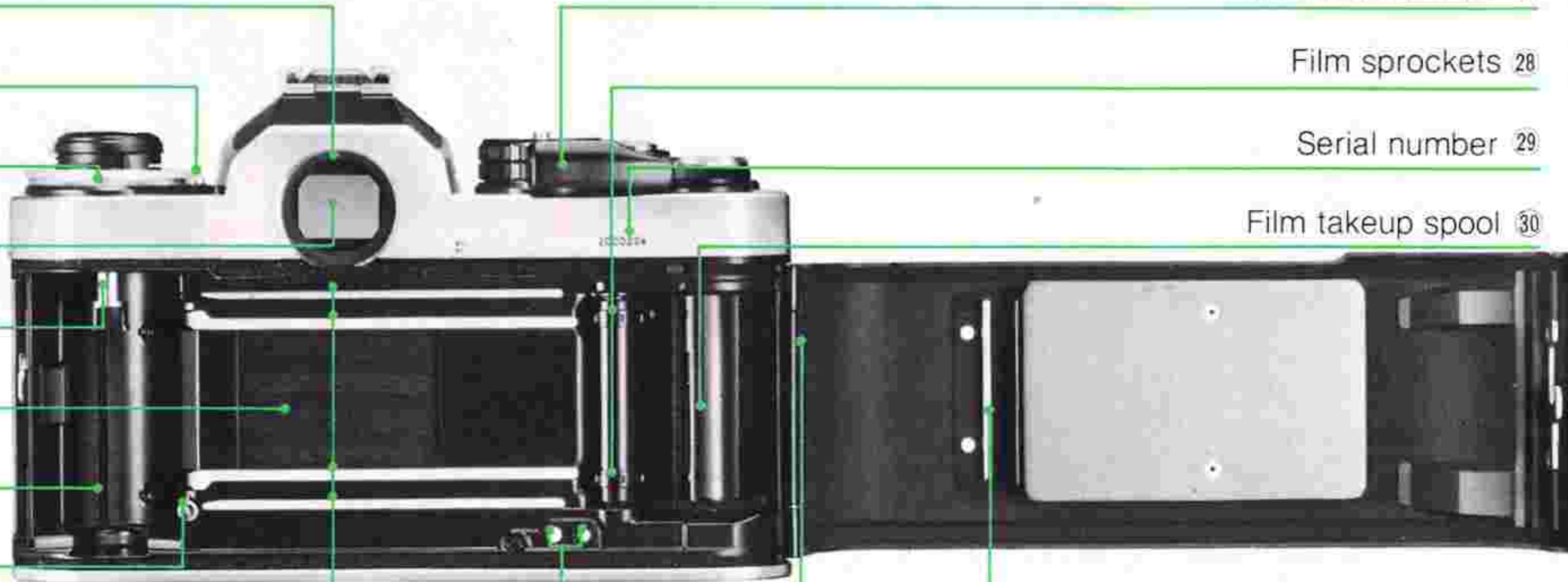

③③ Depth-of-field indicators

③④ Aperture/distance scale index

③⑤ Infrared focusing index

③⑥ Meter coupling shoe

③⑦ Meter coupling ridge

③⑧ Monitor contact

③⑨ Hot-shoe contact

④① Exposure compensation dial

④② ASA/ISO film speed index

④③ Film rewind crank

④④ Camera back lock lever

④⑤ Exposure compensation scale

④⑥ Exposure compensation index

④⑦ Motor drive coupling

④⑧ Motor drive shutter coupling

④⑨ Film rewind button

④⑩ Camera back

⑤① Memo holder

Distance scale ⑤①

Focusing ring ⑤②

Lens mounting ring ⑤③

Aperture ring ⑤④

Aperture scale ⑤⑤

Aperture-direct-readout scale ⑤⑥

Shutter speed/mode index ⑤⑦

Multiple exposure lever ⑤⑧

Frame counter ⑤⑨

Film plane indicator ⑥①

Accessory shoe ⑥②

TTL flash auto-stop signal contact ⑥③

Ready-light contact ⑥④

Motor drive electrical contacts ⑥⑤

Battery chamber lid ⑥⑥

Tripod socket ⑥⑦

Film pressure plate ⑥⑧

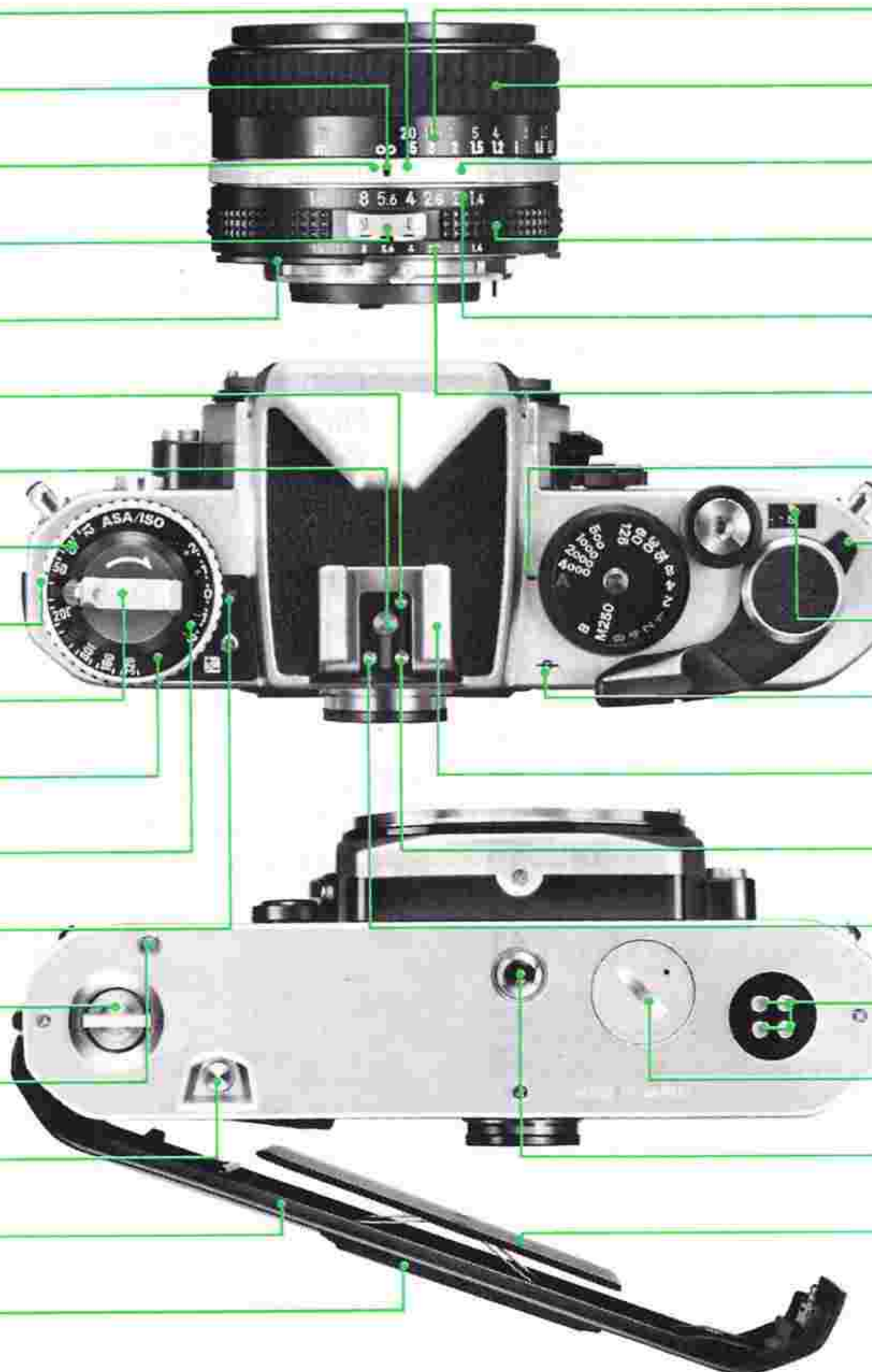

# CONTENTS

---

<b>NOMENCLATURE</b> .....	2—3	<b>CLOSE-UP PHOTOGRAPHY</b> .....	43—44
<b>FOREWORD</b> .....	5	<b>FLASH PHOTOGRAPHY</b> .....	45—49
<b>BASIC OPERATION</b> .....	6—18	Accessory Shoe.....	47
<b>IMPORTANT!</b> .....	19	Viewfinder ready-light.....	48—49
<b>CONTROLS IN DETAIL</b> .....	20—42	<b>ACCESSORIES</b> .....	50—58
Shutter Speed/Mode Selector Dial.....	20—21	Interchangeable Focusing Screens.....	50—51
Exposure metering system.....	21	Electronic Flash Units.....	52
Exposure indications.....	22	Motor Drive MD-12.....	53
Automatic exposure photography—		Data Back MF-16.....	54
aperture priority shooting.....	23—24	Anti-Cold Battery Pack DB-2.....	55
Automatic exposure photography—		Cable Release AR-3.....	55
shutter speed priority shooting.....	24	Right-Angle Viewing Attachment DR-3.....	56
Manual exposure photography.....	25—27	Eyepiece Magnifier DG-2.....	56
Stop-Down Exposure Measurement.....	28	Rubber Eyecup.....	56
EV Range of the Camera.....	29—31	Eyepiece Correction Lenses.....	56
Shutter Release Button.....	32	Filters.....	57
Film Advance Lever.....	33	Lens Hoods.....	57
Frame Counter.....	33	Camera Cases.....	58
ASA/ISO Film Speed Dial.....	34	Neckstraps.....	58
Exposure Compensation.....	35	Compartment Cases.....	58
Exposure Compensation Dial.....	35—36	<b>TIPS ON BATTERY USE</b> .....	59
Memory Lock.....	37	<b>TIPS ON CAMERA CARE</b> .....	60—61
Depth-of-Field Preview Lever.....	38—39	<b>SPECIFICATIONS</b> .....	62—63
Multiple Exposure Lever.....	40		
Self-Timer Lever.....	41		
Memo Holder.....	41		
Infrared Focusing Index.....	42		
Film Plane Indicator.....	42		

# FOREWORD

---

Congratulations! You now own the fastest SLR camera on the market today. With a maximum shutter speed of 1/4000 sec., you can halt the most fleeting action literally in its tracks. Complemented by a flash synchronization speed of 1/250 sec., the fastest in 35mm SLR photography, the FE2 makes it easy to fill in the shadows in strong daylight. These speeds are made possible by Nikon's advanced camera technology, employing lightweight honeycomb-etched, vertical-traveling, titanium shutter curtains.

In addition to aperture-priority automatic exposure from 1/4000 sec. to 8 sec., the FE2 offers full manual exposure control with accuracy ensured by digital quartz timing. The camera also has a battery power-saving feature: a light touch of the lockable shutter release button activates the meter, which then automatically switches off 16 seconds later.

Other exciting features include three bright interchangeable focusing screens, automatic TTL flash photography with a Nikon dedicated flash unit, plus rapid film advance up to 3.2 frames per second with a motor drive.

To obtain the best results, keep this instruction manual handy until you've become thoroughly familiar with the FE2's operation. A few minutes wisely invested now will pay off later in many years of rewarding photographic experiences.

# BASIC OPERATION

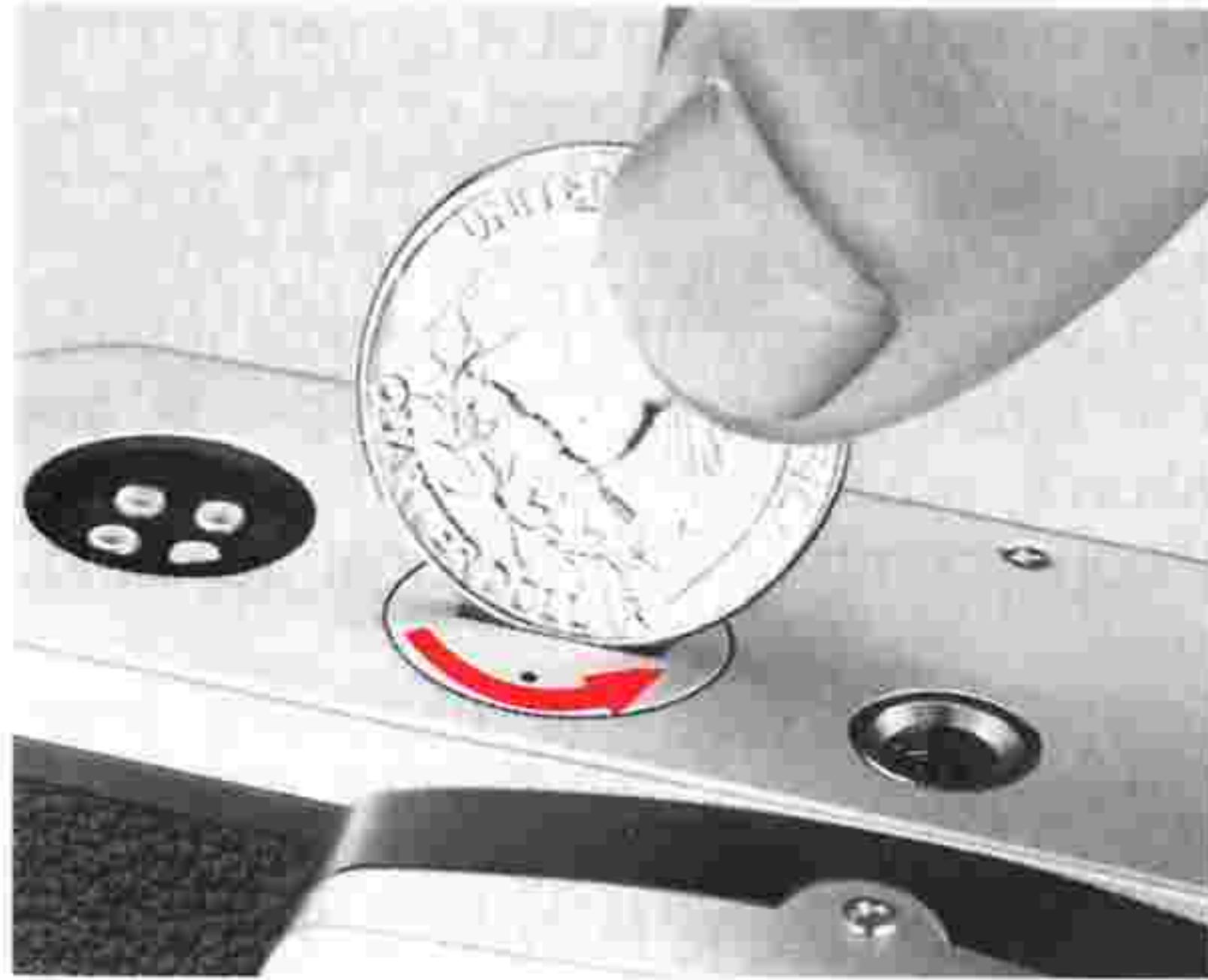

- 1. Remove the battery clip.** Turn the camera upside down and use a coin to unscrew the battery clip lid <sup>65</sup> in a counterclockwise direction.



- 2. Install the battery.** Wipe battery terminals clean and insert the battery into the battery clip in accordance with the marks provided in the clip, **making sure the + sign is up.** Usable batteries are:  
1) one 3V lithium battery; 2) two 1.55V silver-oxide batteries (3.1V), or 3) two 1.5V alkaline-manganese batteries (3V).

**Caution:** Keep batteries away from infants and small children. In case a battery is accidentally swallowed, call a doctor immediately as the material inside the batteries can cause serious problems.



- 3. Put the battery clip back into place.** Slip the battery clip back into the camera body baseplate and screw the lid clockwise tightly into place.

**Note:** For more information on batteries, refer to page 59.

**Note:** The small numbers in the circles identify parts of the camera as listed in the NOMENCLATURE section.

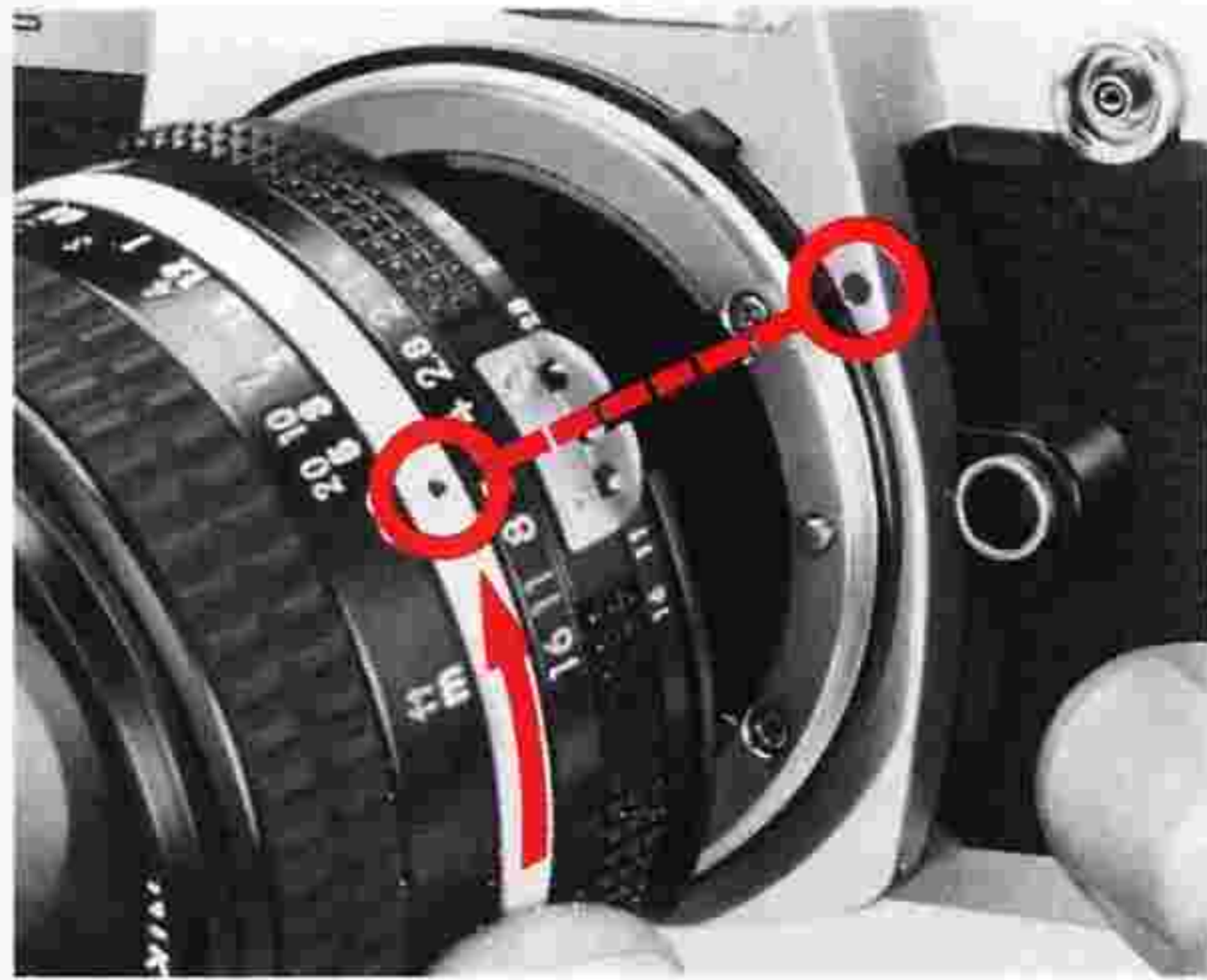

#### 4. Mount the lens.

Place the lens on the camera, lining up the aperture/distance index on the lens ③④ with the lens mounting index on the camera body ②③. Then twist the lens mounting ring counterclockwise until the lens clicks into place. Confirm that the aperture/distance index is right on top.

#### Notes:

- 1) When changing lenses with film loaded in the camera, be careful not to expose the mirror box to direct sunlight.
- 2) This camera is designed exclusively for use with AI lenses. Non-AI lenses cannot be used, with a few exceptions; please refer to page 19 for more details.

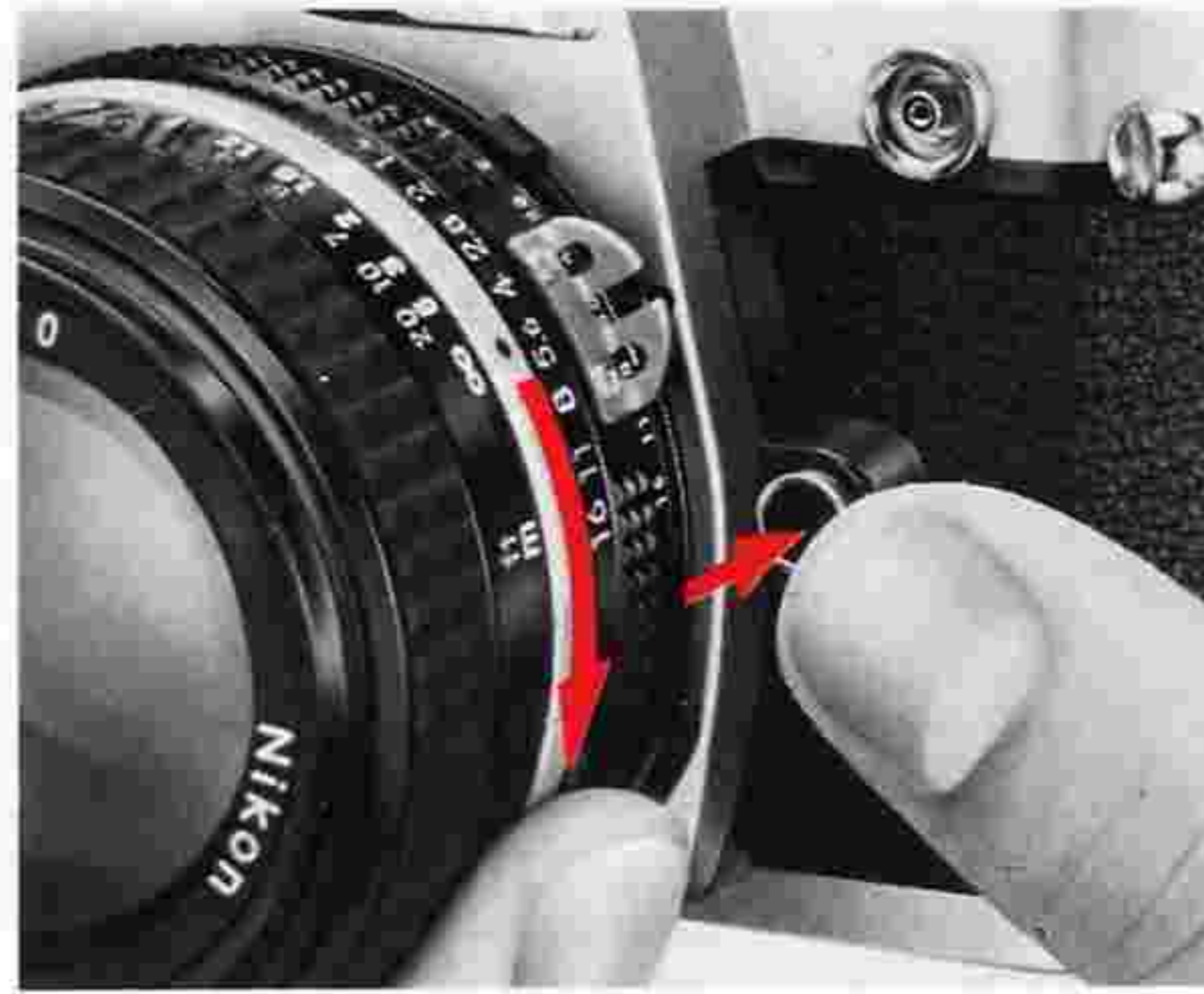

**To remove:** While pushing the lens release button ②④, turn the lens mounting ring ⑤③ clockwise until the lens comes off.

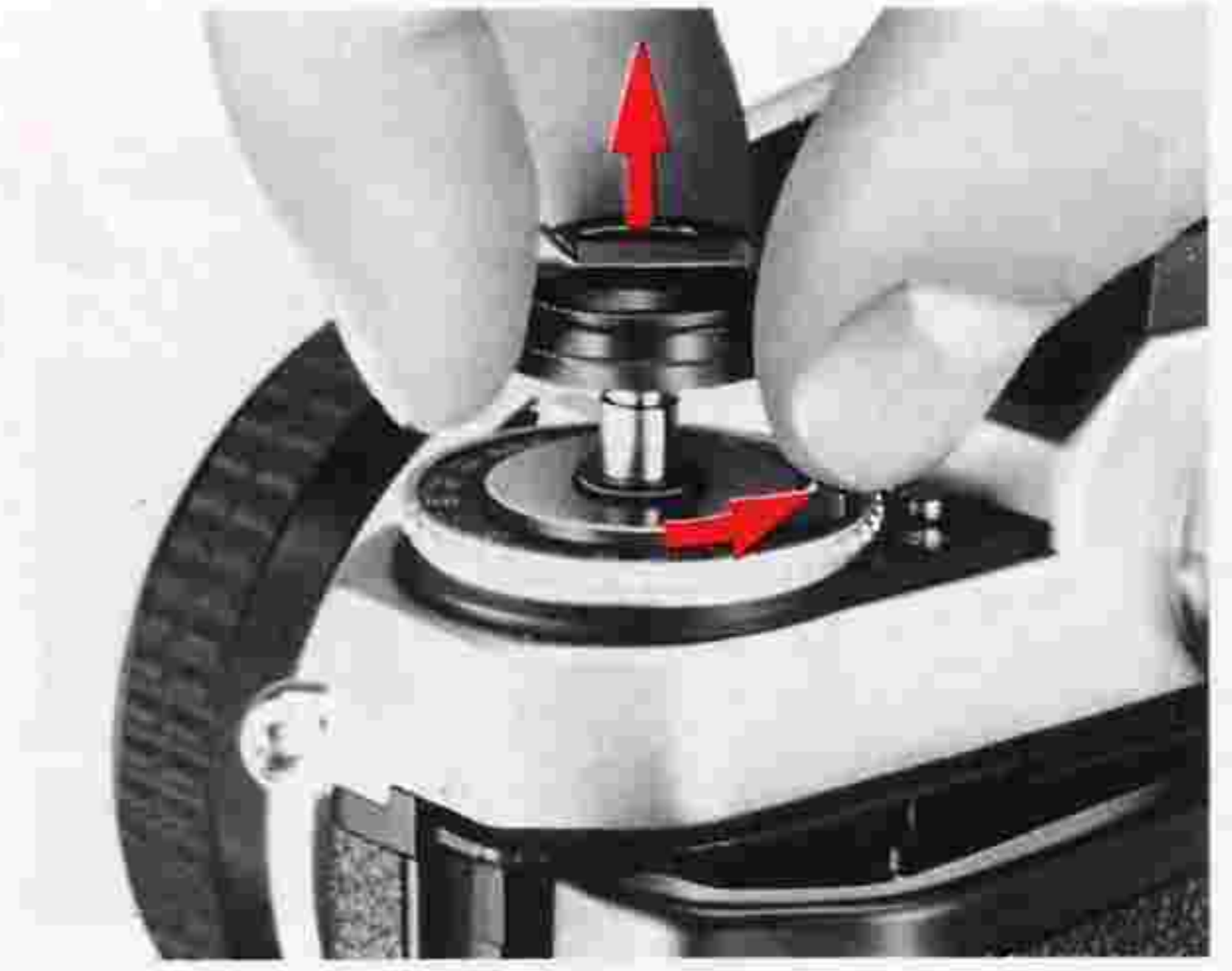

#### 5. Open the camera back ④⑨.

While pushing the camera back lock lever ④③ counterclockwise with your finger, pull up the film rewind knob ②①. Then lift up further until the camera back pops open.

**Caution:** Never touch the shutter curtains.

# BASIC OPERATION—continued



## 6. Install the film cartridge.

Position the film cartridge in the film cartridge chamber ⑮ with the film leader pointing towards the takeup spool, and push the rewind knob back down to secure the cartridge in place.

### Notes:

- 1) You can use any 35mm film cartridge available on the market.
- 2) Avoid loading film in direct sunlight. If there is no shade available, turn your back to the sun and use your own shadow to shield the camera.

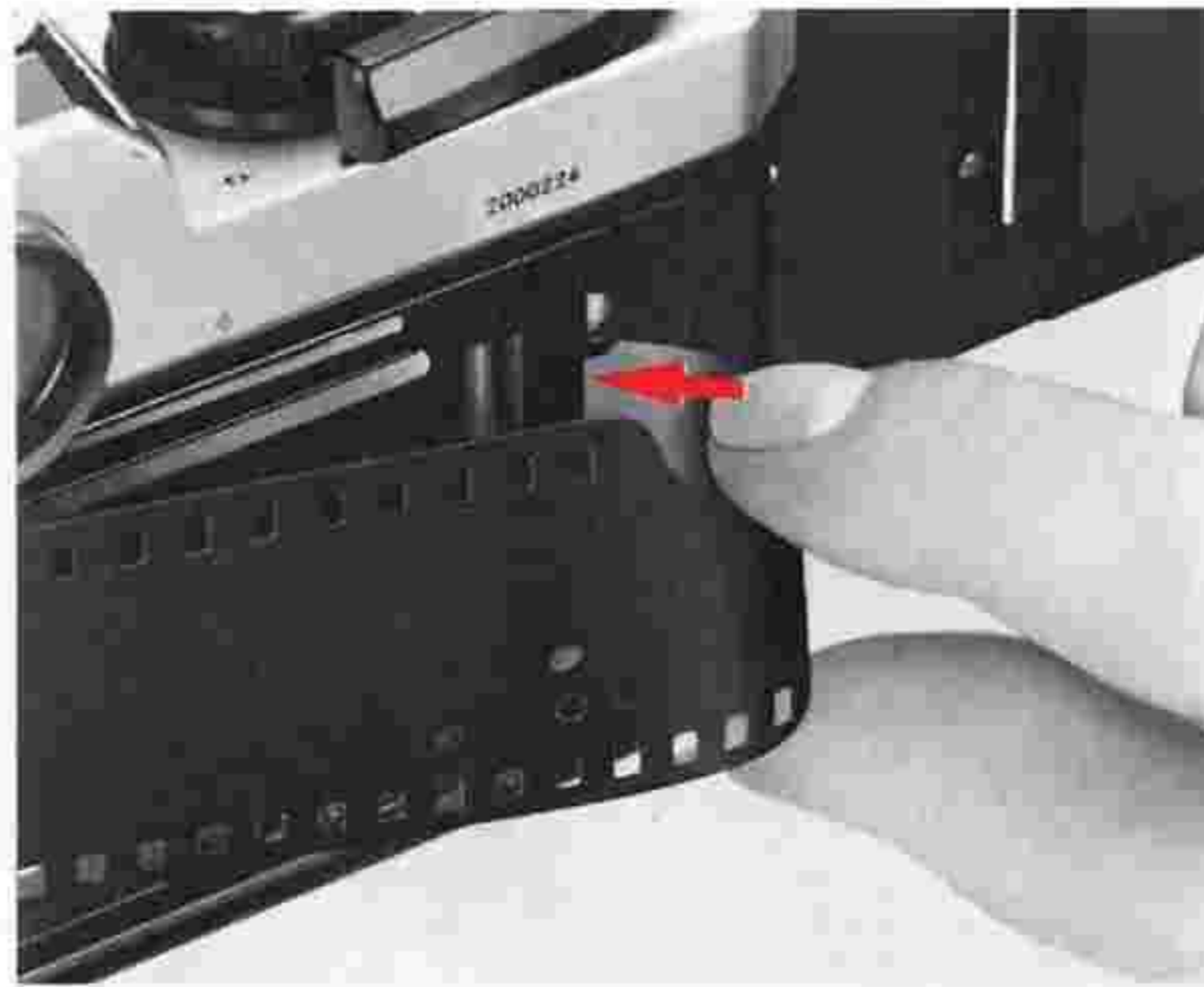

## 7. Insert the film leader in the takeup spool ⑳.

Pull the leader across the camera and insert it into any one of the slots in the takeup spool.

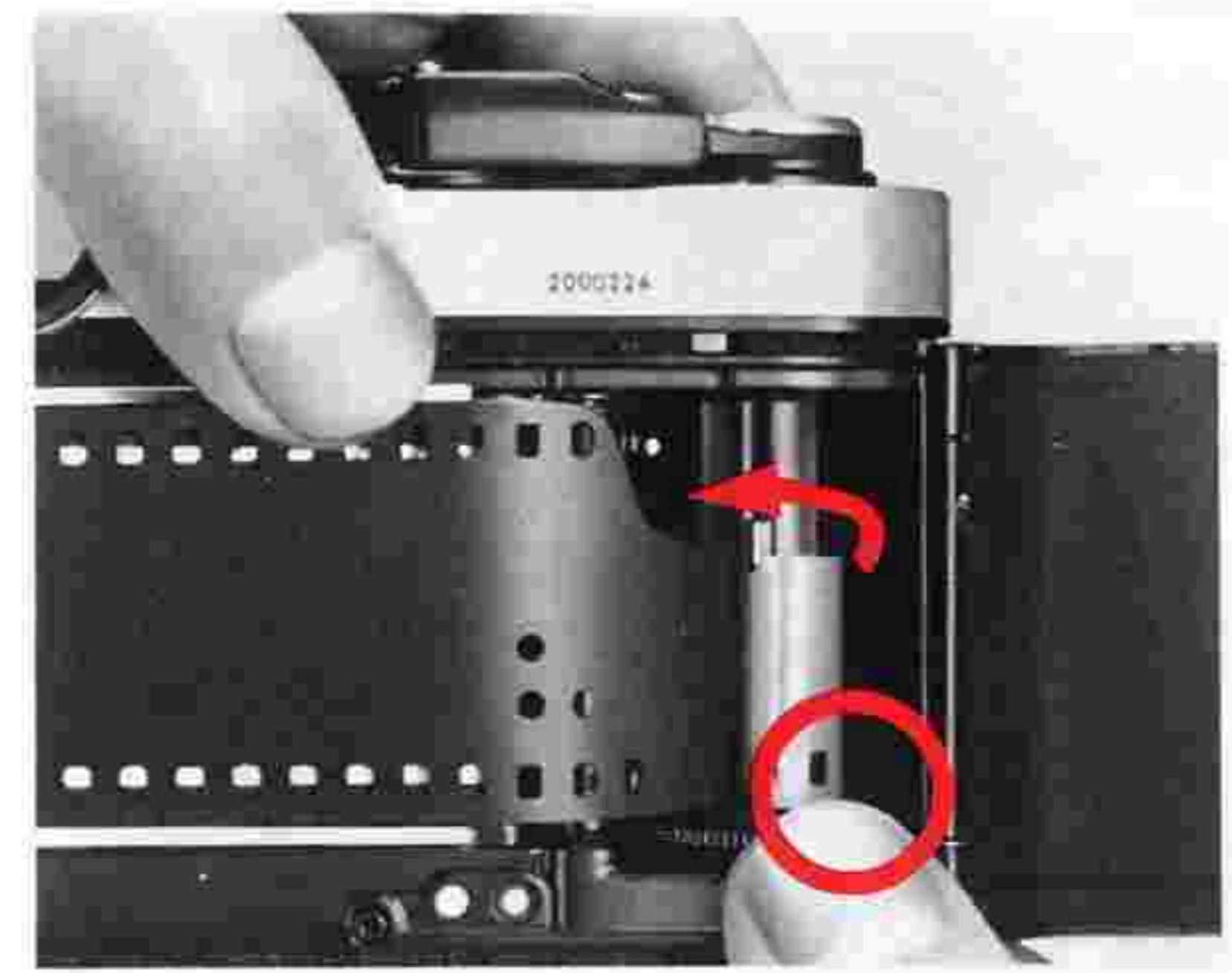

## 8. Engage the film's perforations with the sprocket teeth ㉘.

Turn the takeup spool slightly with your finger, so that the first or second perforation at the bottom edge of the film is engaged with the small tooth at the bottom of the slot in the takeup spool and the top and bottom perforations mesh securely with the film sprockets.



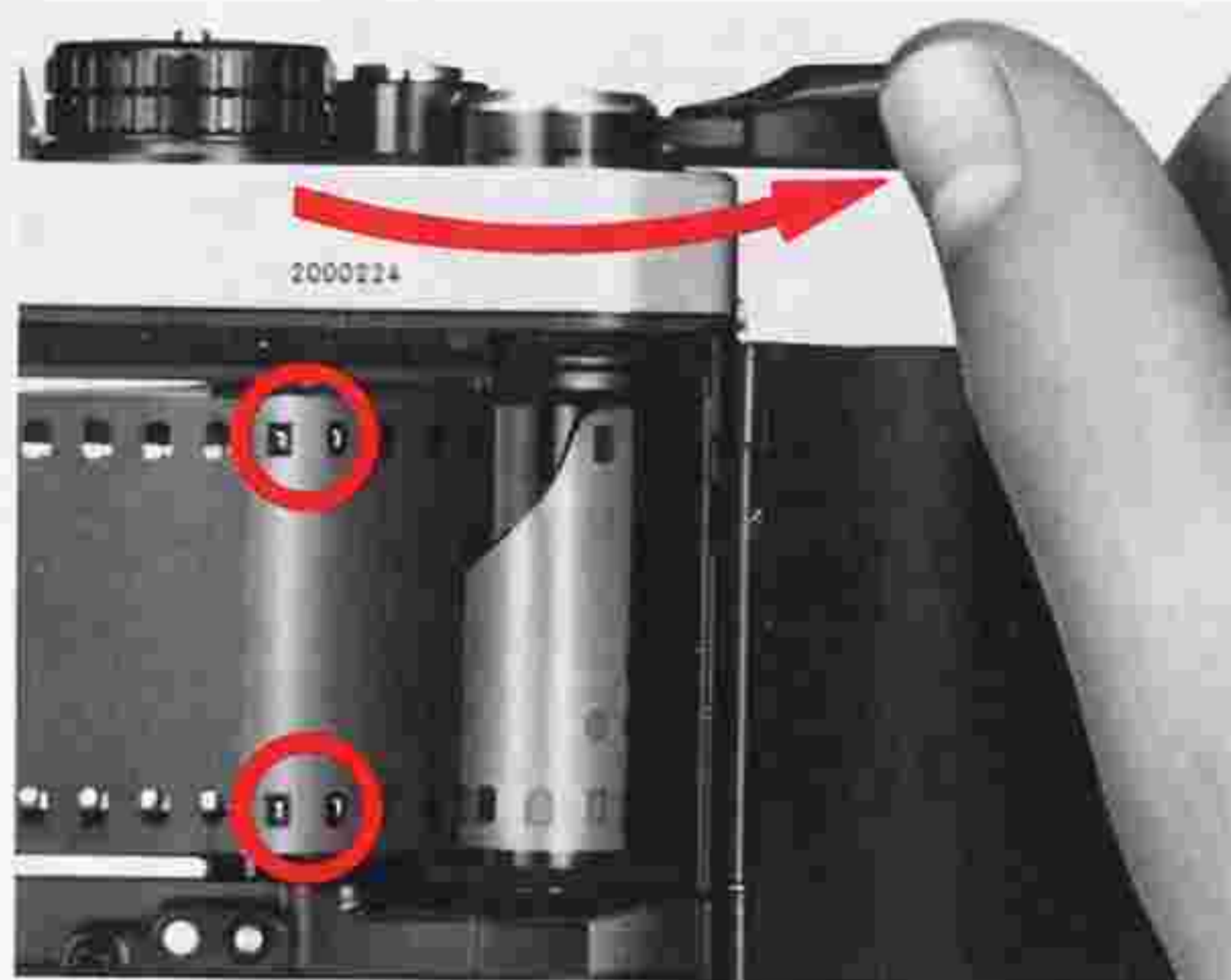

## 9. Advance the film with the film advance lever ⑳.

Pull out and wind the film advance lever, making sure the perforations on both film edges are securely engaged with the sprocket teeth and the film is advanced properly. Also confirm that the film is located properly between both film guide rails ⑰ and there is no film slack.

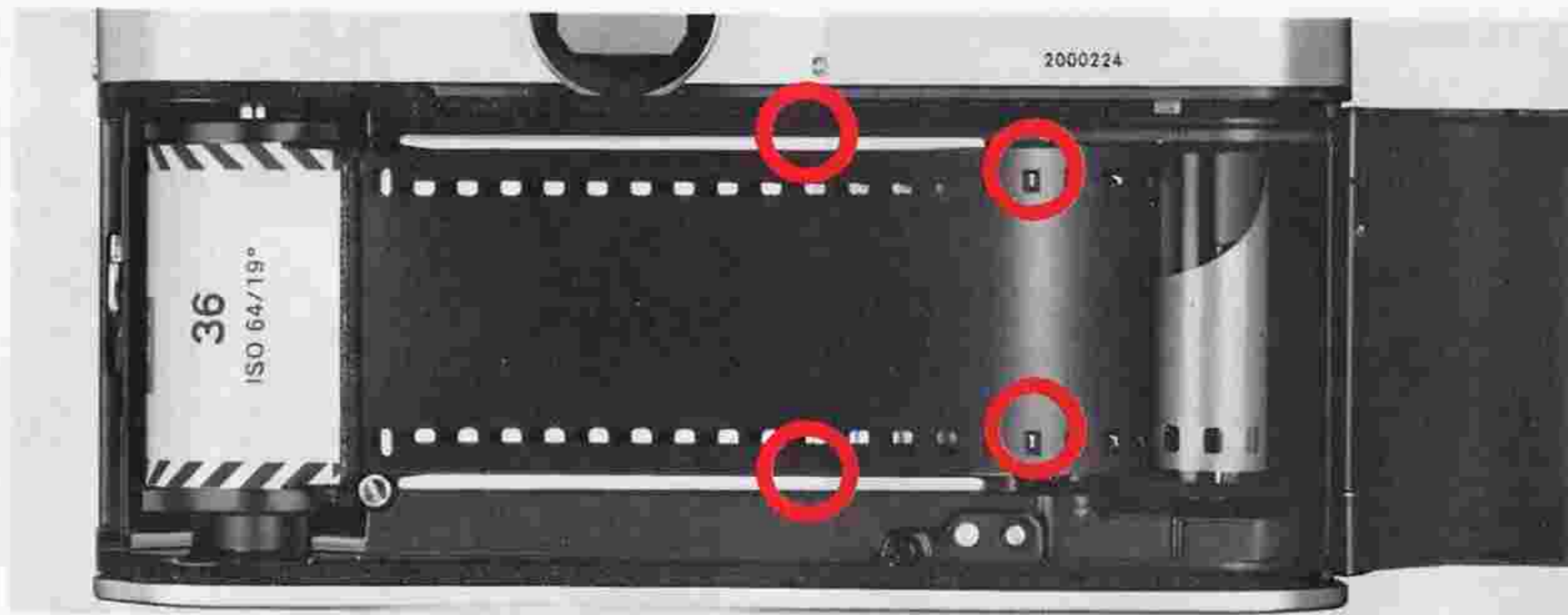

## BASIC OPERATION—continued



### 10. Close the camera back.

Snap the camera back shut.

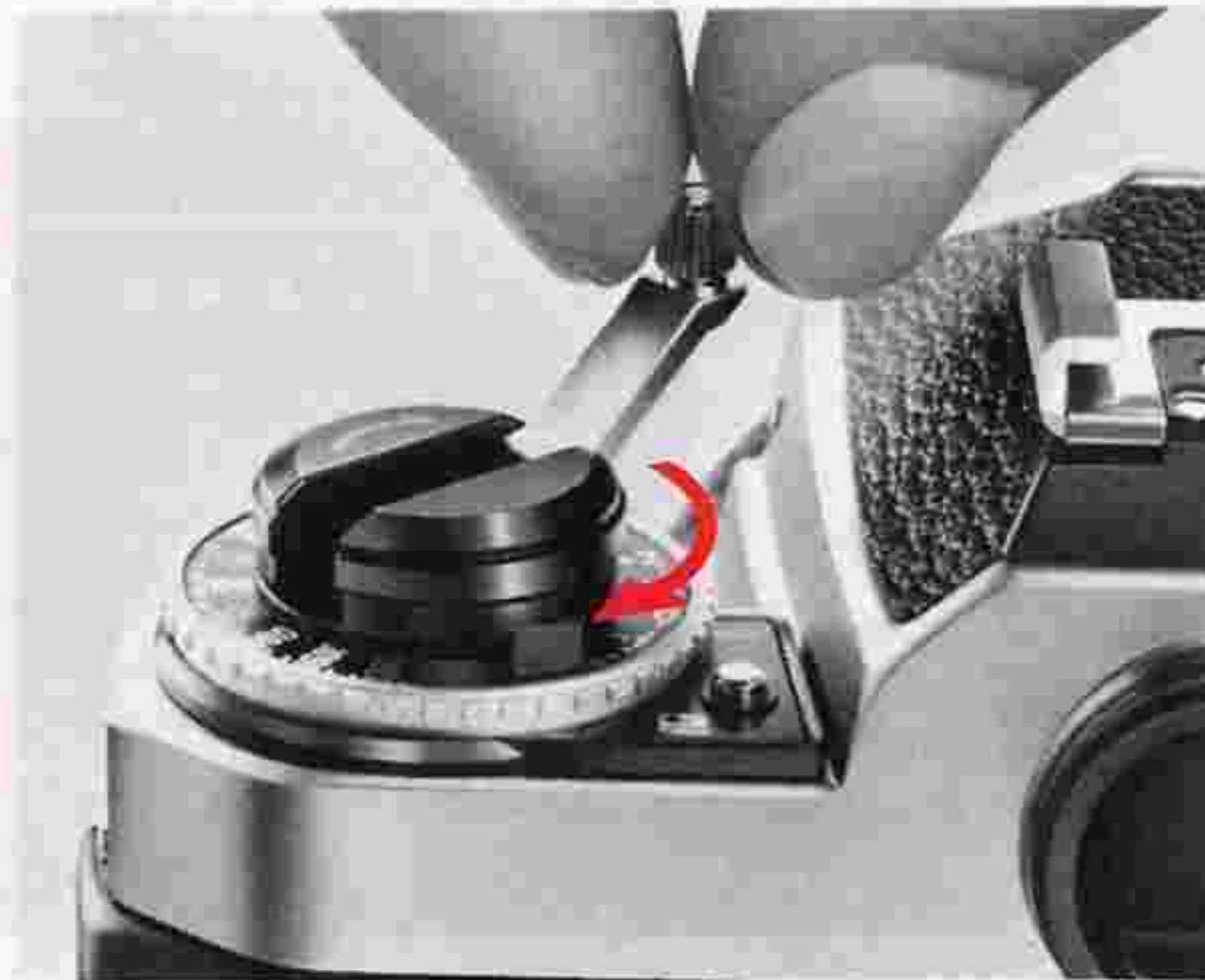

### 11. Take up film slack.

Fold out the film rewind crank ④<sup>2</sup> and rotate it gently in the direction of the arrow on the film rewind knob until you feel a slight resistance. Then fold the crank back in.



### 12. Set the ASA/ISO film speed ring ⑪.

Lift up the ASA/ISO film speed ring and rotate it in either direction until the index dot ④<sup>1</sup> is opposite the film speed in use. Make sure the exposure compensation dial ④<sup>0</sup> is set at 0. These actions are essential to activate the camera's exposure meter for correct exposure of the film in use.

#### Notes:

- 1) The film speed is printed on the film carton and the cartridge itself.
- 2) If the exposure compensation dial is not at 0, refer to page 36 for details.



### 13. Make blank exposures until the frame counter ⑤9 reaches frame "1."

The film advance lever doubles as a shutter release button lock: to unlock the shutter release button ②, pull out the film advance lever to the standoff position as shown in the photo. To dispose of the first few frames exposed during film loading, continue to alternately advance the film and depress the shutter release button until the frame counter reaches frame "1." Check that the rewind knob is rotating, indicating the film has been loaded correctly and is being advanced. If the knob does not rotate, reload the film.

#### Notes:

- 1) Set the shutter speed/mode selector dial ⑱ to A or a fast shutter speed while making blank exposures.
- 2) Up to frame "1," the meter needle in the viewfinder does not move and this indicates that the meter is not functioning; therefore do not take pictures prior to the first frame.

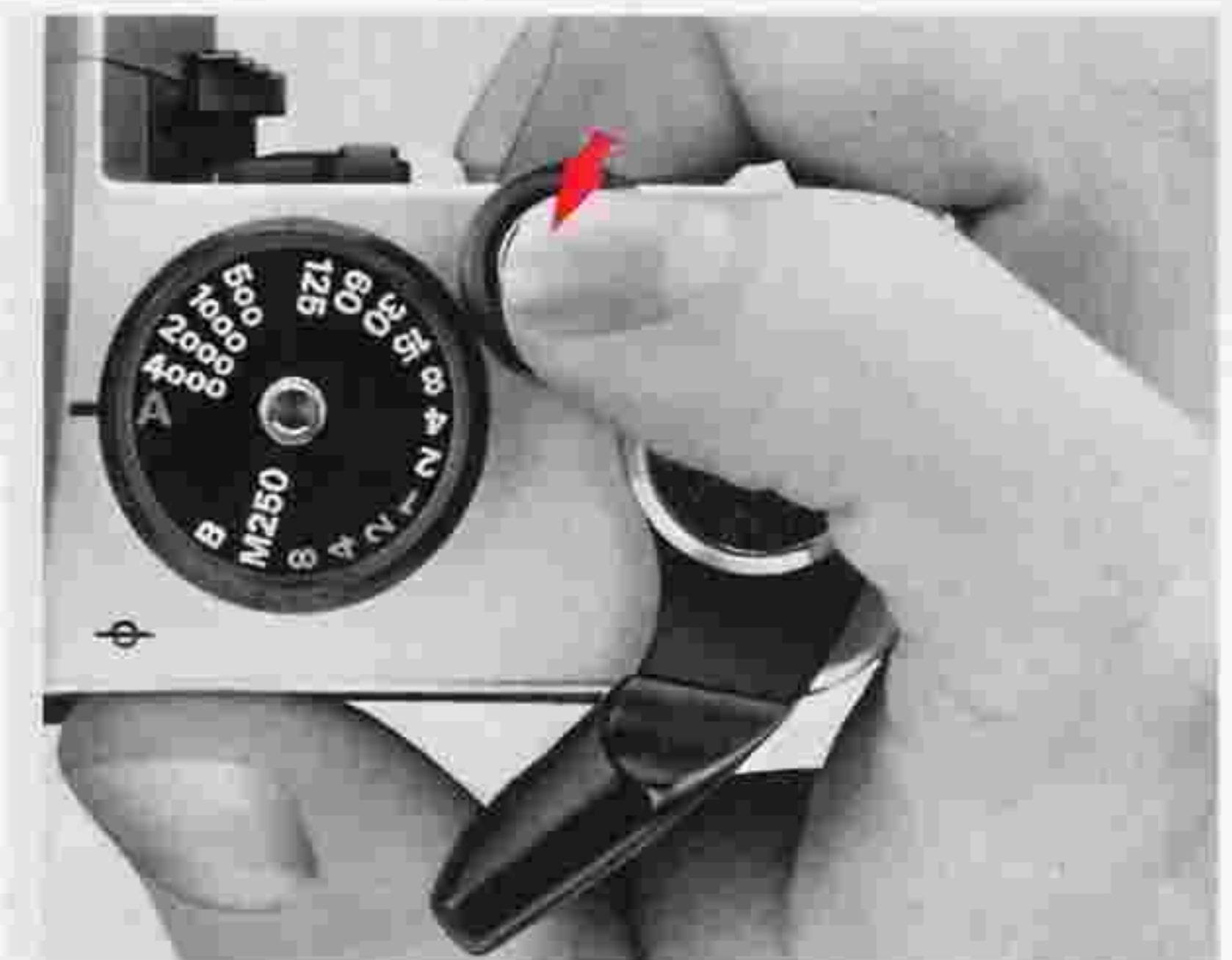

### 14. Press the shutter release button lightly to switch the exposure meter on.

The shutter release button activates the exposure meter when lightly pressed. The meter stays on for approx. 16 sec. after you have taken your finger off the button.

## BASIC OPERATION—continued

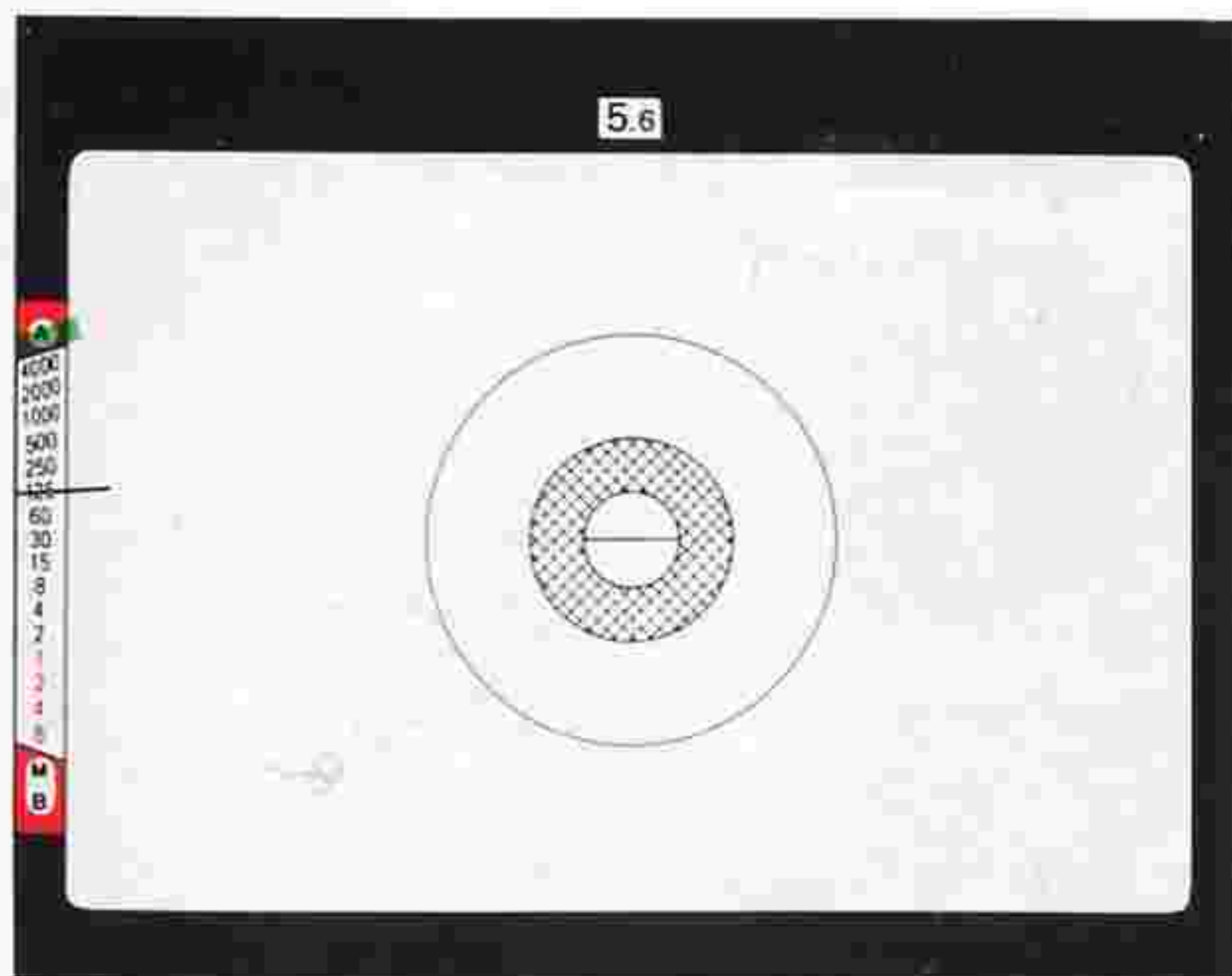

### 15. Check battery power.

While looking through the viewfinder ⑫ after switching the exposure meter on, if the black meter needle swings into the shutter speed scale range, this indicates that the exposure meter is working properly.

#### Notes:

- 1) When the shutter speed dial is set at B (Bulb) or M250 (1/250 sec.), the black meter needle doesn't move; therefore you cannot check the batteries. Be sure to set the dial to another position. If the black meter needle still doesn't move, either the battery is improperly installed (in which case you should install it properly) or battery power is not sufficient (in which case you should change the battery).
- 2) You cannot check the battery power until the frame counter reaches "1."

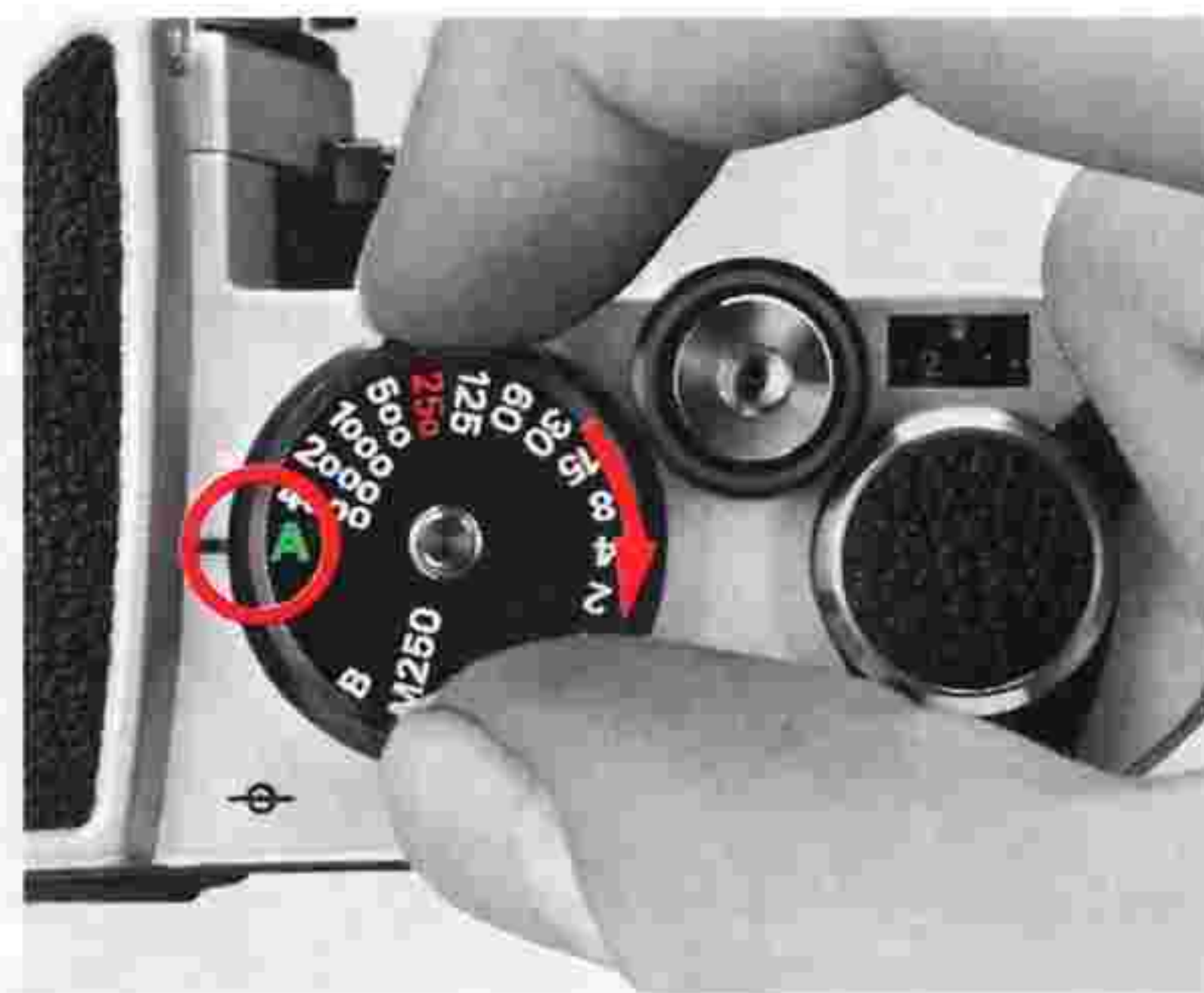

### 16. Set the shutter speed dial to "A" (for automatic operation).

Rotate the shutter speed dial until the "A" is opposite the shutter speed/mode index ⑤7. The built-in locking mechanism ensures that the dial cannot be accidentally shifted from the "A" (auto position) during shooting.

**Note:** The Nikon FE2 camera has one more shooting mode besides aperture-priority auto exposure: manual operation. For details about shooting in this mode, refer to pages 25—26.



## 17. Set the lens aperture.

Turn the lens aperture ring 54 until the desired f-number is opposite the aperture/distance index on the lens. The selected f-number appears in the viewfinder through the ADR (aperture direct readout) window for convenient reference. Intermediate settings on the lens aperture ring can be used.

Use the following suggestions as a guide in setting the f/stop on the lens (when a 50mm f/1.4 is used with ASA/ISO 100 film speed):

Outdoors (cloudy): f/2.8~f/5.6

Outdoors (clear): f/5.6~f/11

Outdoors (clear at the beach or in the mountains): f/11~f/16

**Note:** The depth of field as well as the shutter speed can be controlled by your selection of the shooting aperture. For more information, refer to pages 38—39.



## 18. Hold the camera steady.

Many blurred shots are caused by unsteady holding of the camera. Basic holding posture: Use your left hand to cradle the camera, with your fingers wrapped around the lens and elbow propped against your body for support, as you look through the viewfinder. Use your right hand's index finger to depress the shutter release button and your thumb to wind the film advance lever. Wrap the other fingers of your right hand around the camera body. You can adapt this basic posture to both horizontal- and vertical-format shooting. To hold the camera steady, it is advisable to lean on or against something strong and stable (e.g., a wall). Also, you can look through the viewfinder with the right or left eye, with the other eye open or closed.

# BASIC OPERATION—continued

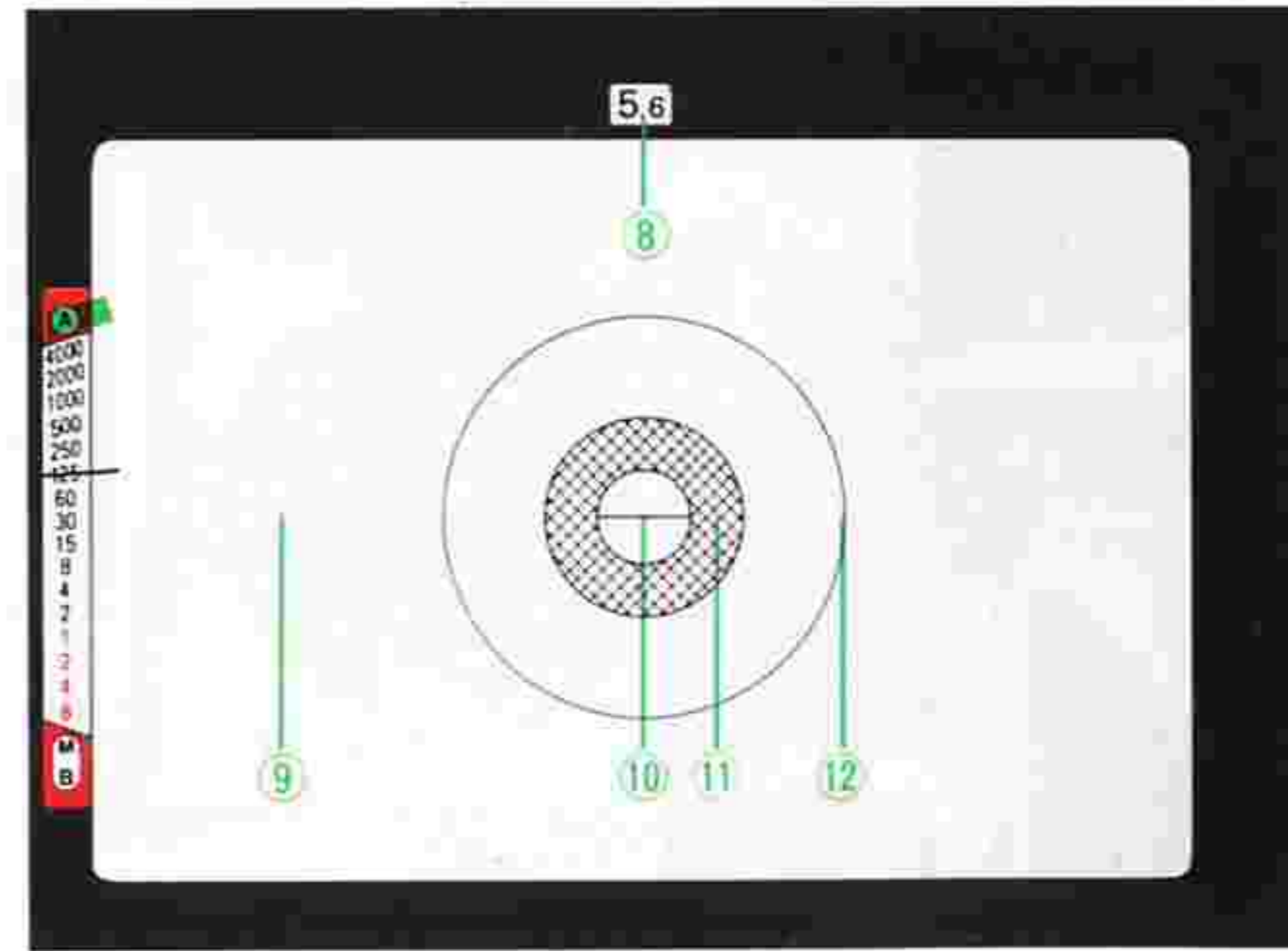
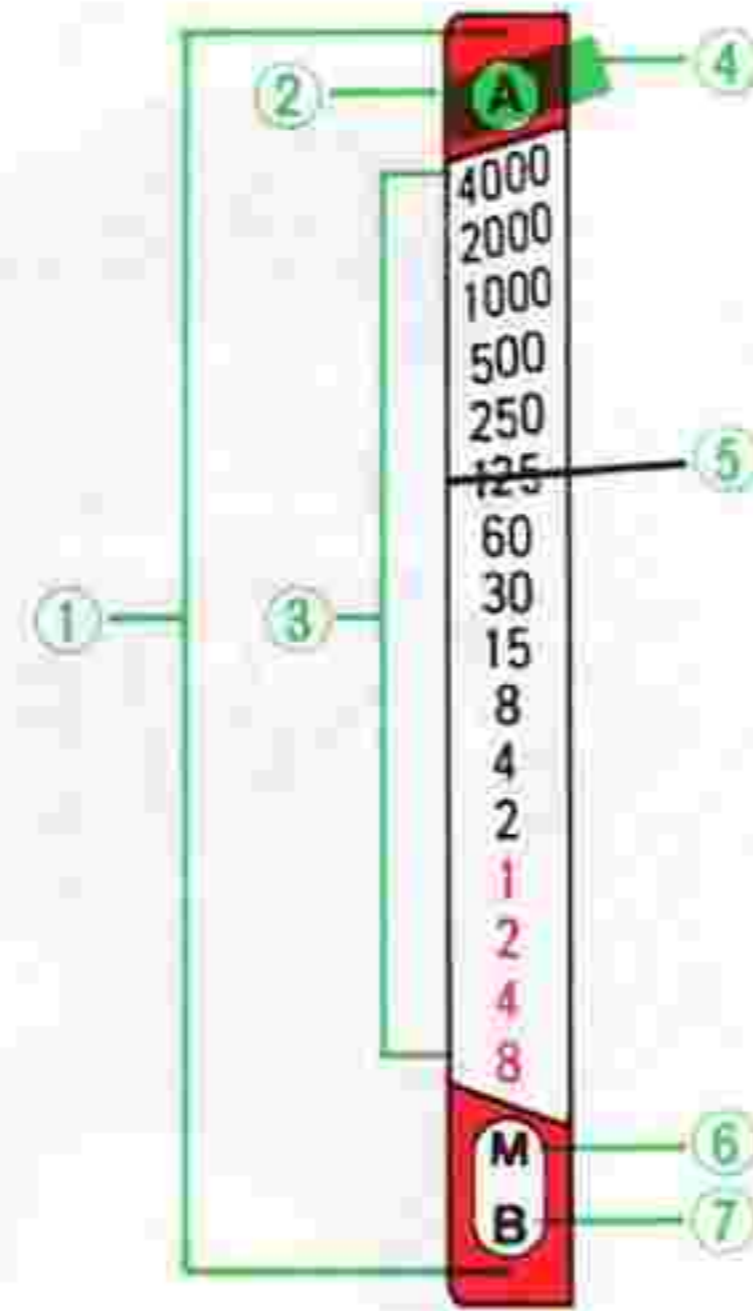

## 19. Compose and focus on the subject.

The FE2 is provided with the Type K2 focusing screen as standard for all-purpose photography. While looking through the viewfinder, compose your photo with the main subject in the center to assure correct exposure. Then turn the focusing ring of the lens (52) until the subject looks clear. For precise pinpoint focusing on subjects with distinct contours, use the central split-image rangefinder; turn the focusing ring until the split image becomes whole (A). For rapid focusing and for subjects with indistinct outlines, use the microprism collar; turn the focusing ring until the shimmering image becomes sharp (B). When taking close-ups or macrophotography or shooting with telephoto lenses of maximum apertures of approx. f/4.5 or smaller, the split-image spot and microprism collar are likely to darken. Therefore, use the matte portion of the screen; turn the focusing ring until the image looks sharp (C).

- |  |                               |
|--|-------------------------------|
| ① Outside-exposure-range warning marks | ⑦ B (Bulb)                    |
| ② A (Auto)                             | ⑧ f-number in use             |
| ③ Shutter speed scale                  | ⑨ Fine matte/Fresnel field    |
| ④ Shutter speed/mode indication needle | ⑩ 3mm dia. split-image spot   |
| ⑤ Meter needle                         | ⑪ 1 mm-wide microprism collar |
| ⑥ M250                                 | ⑫ 12mm dia. area              |

### Notes:

- 1) The shutter speed scale in the viewfinder is color coded: black numbers indicate reciprocal shutter speeds: i.e. 60 means 1/60 sec., while red shows actual shutter speeds.
- 2) The finder coverage of the FE2 is approx. 93%. The actual image size will be slightly larger than the image seen in the viewfinder.

---

**(A) Split-image focusing**

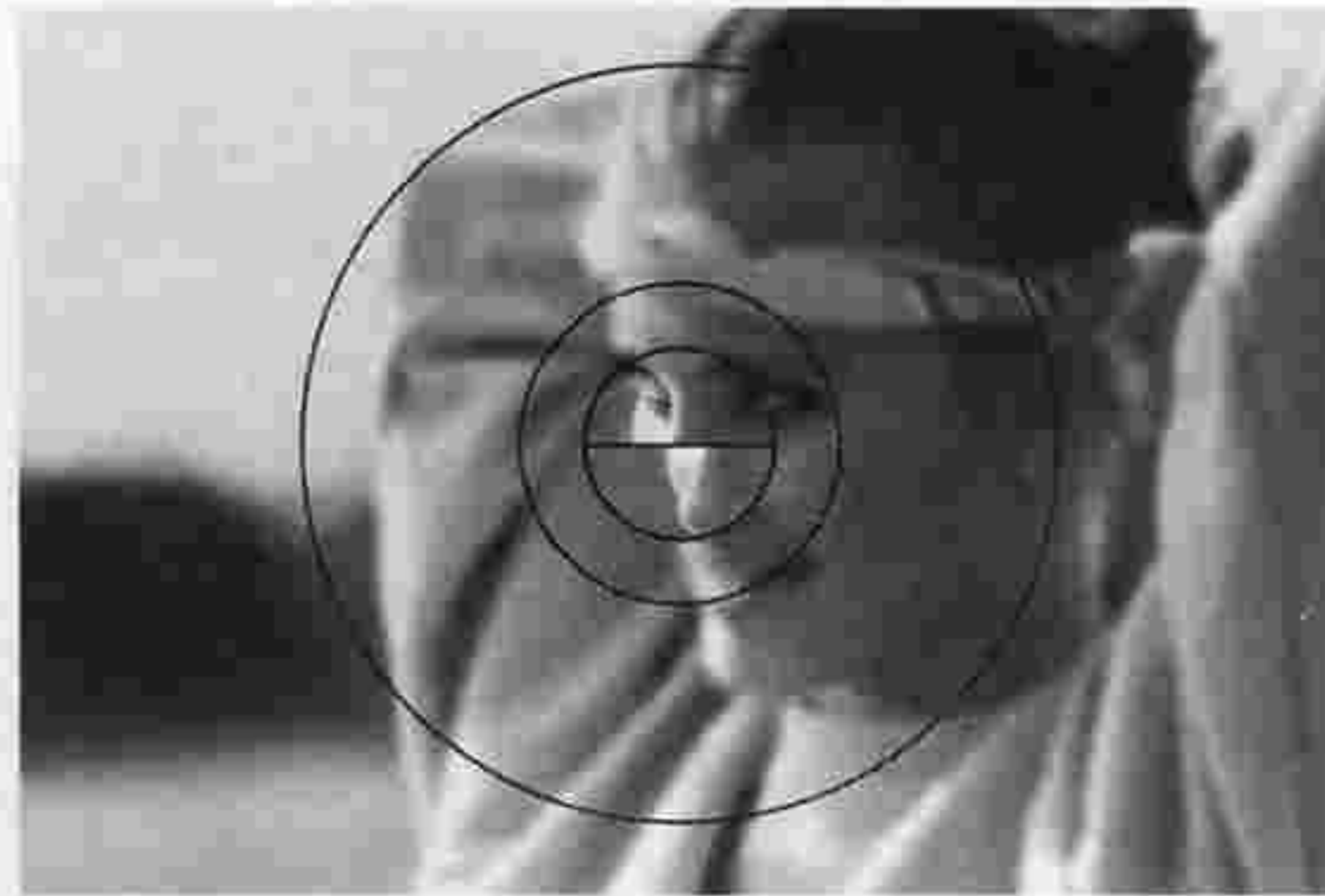

Out of focus

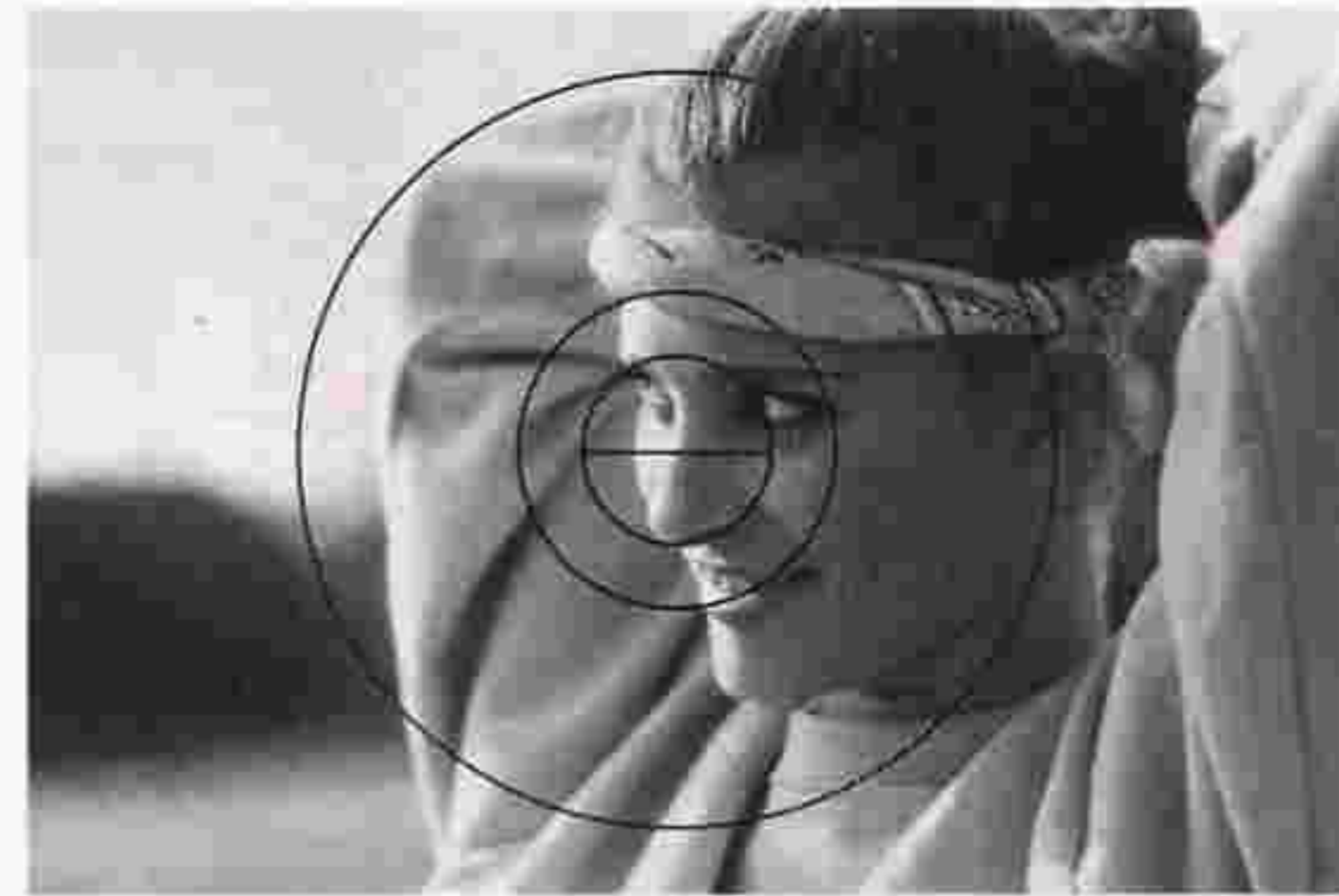

In focus

---

**(B) Microprism focusing**

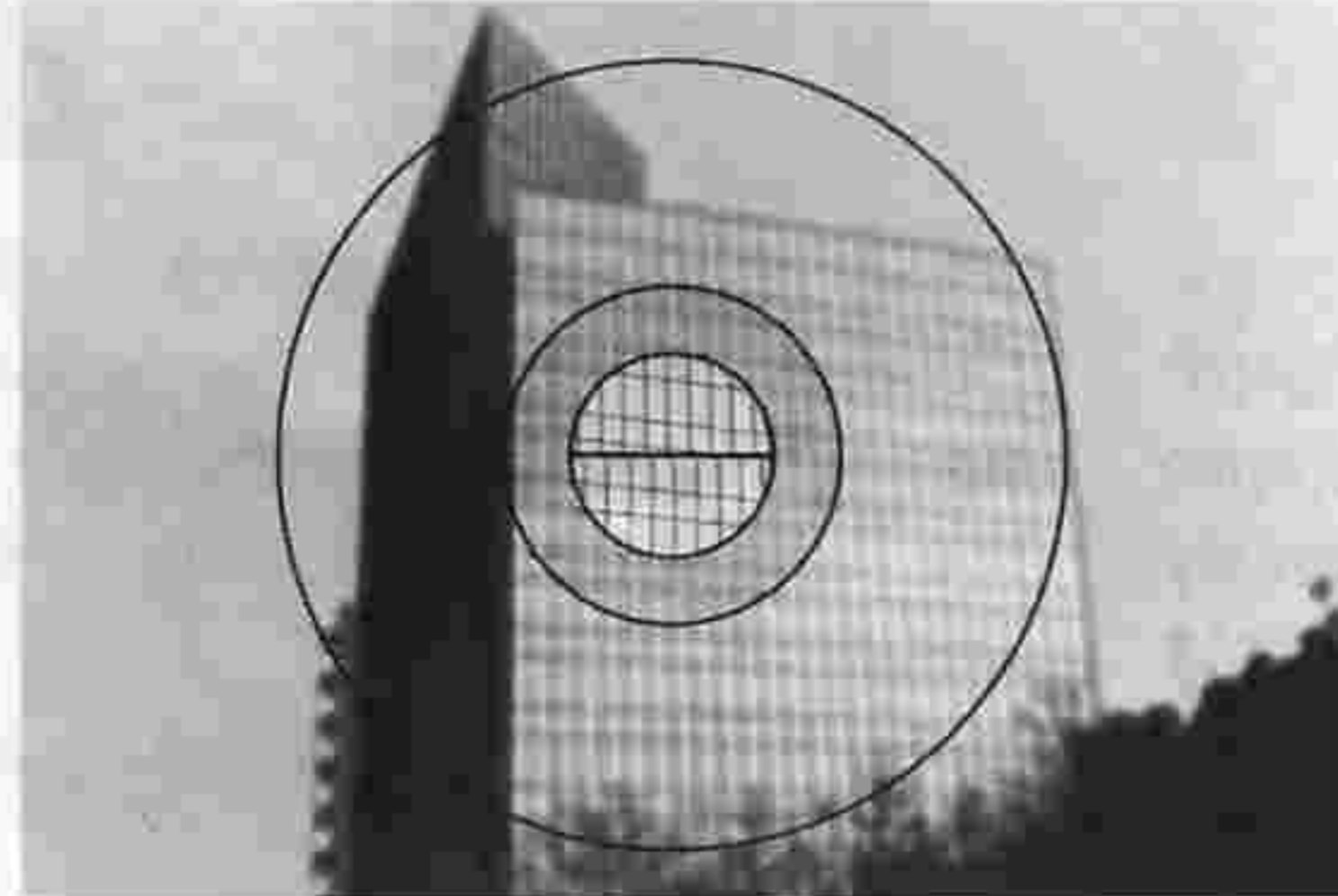

Out of focus

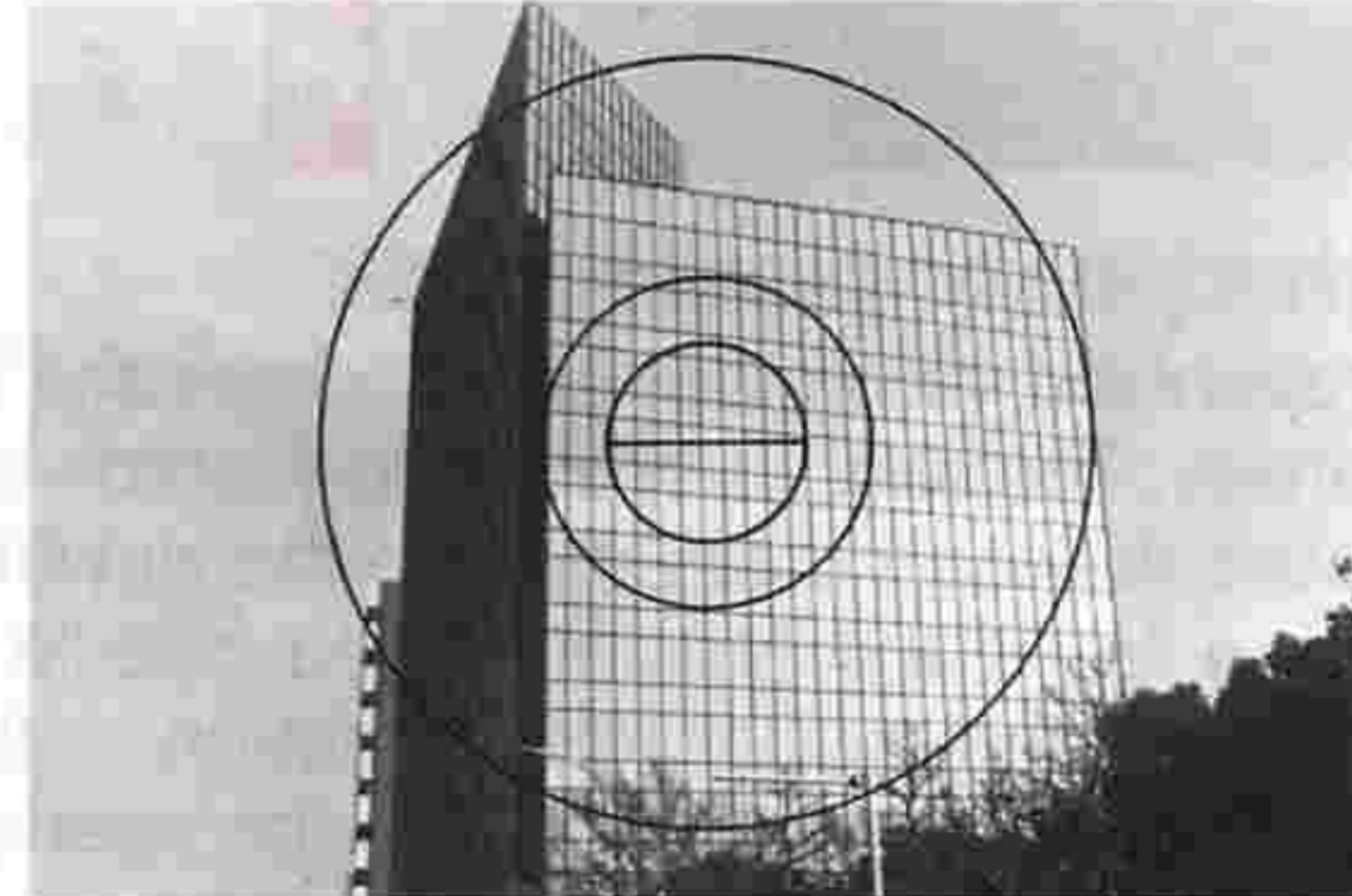

In focus

---

**(C) Matte field focusing**

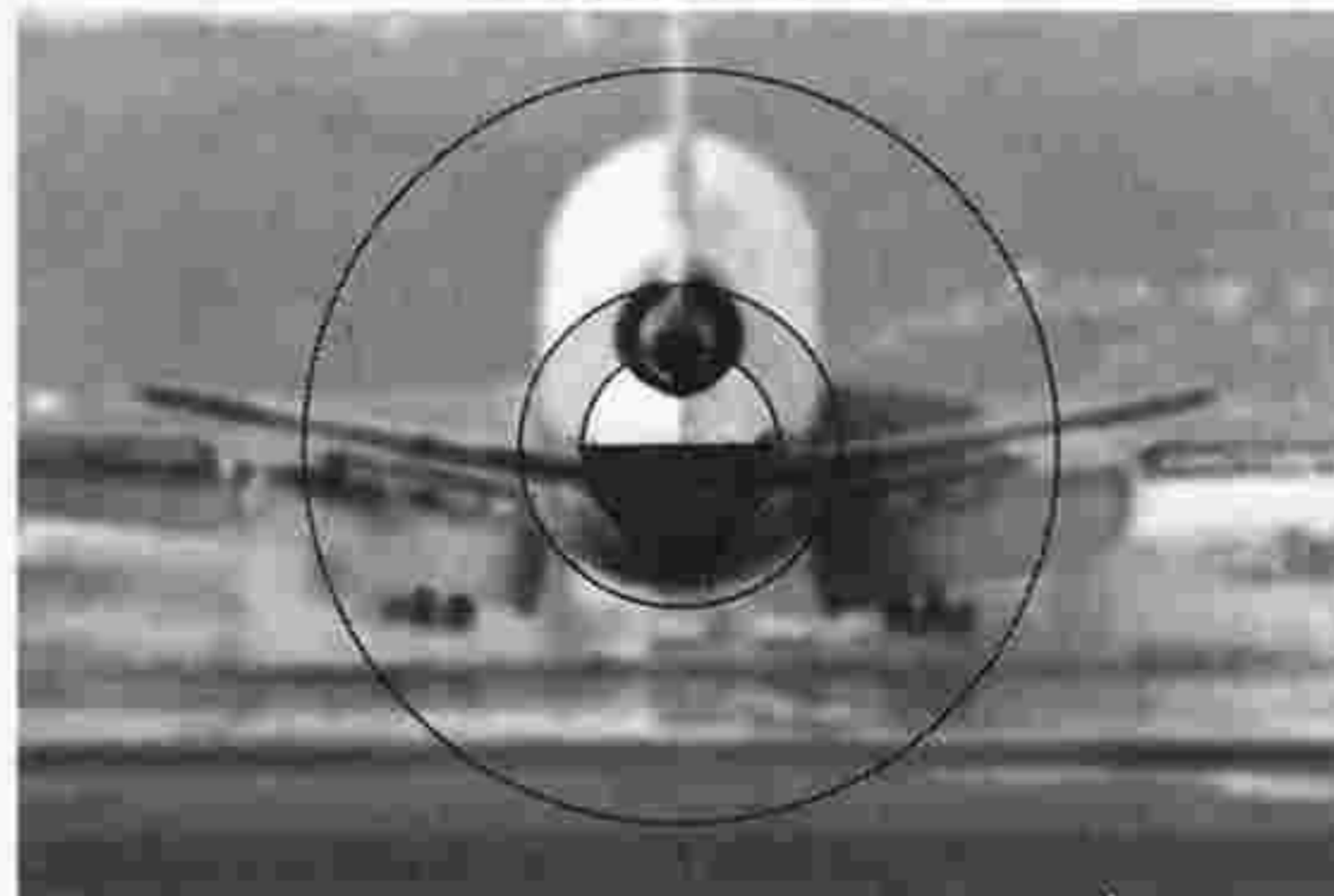

Out of focus



In focus

# BASIC OPERATION—continued

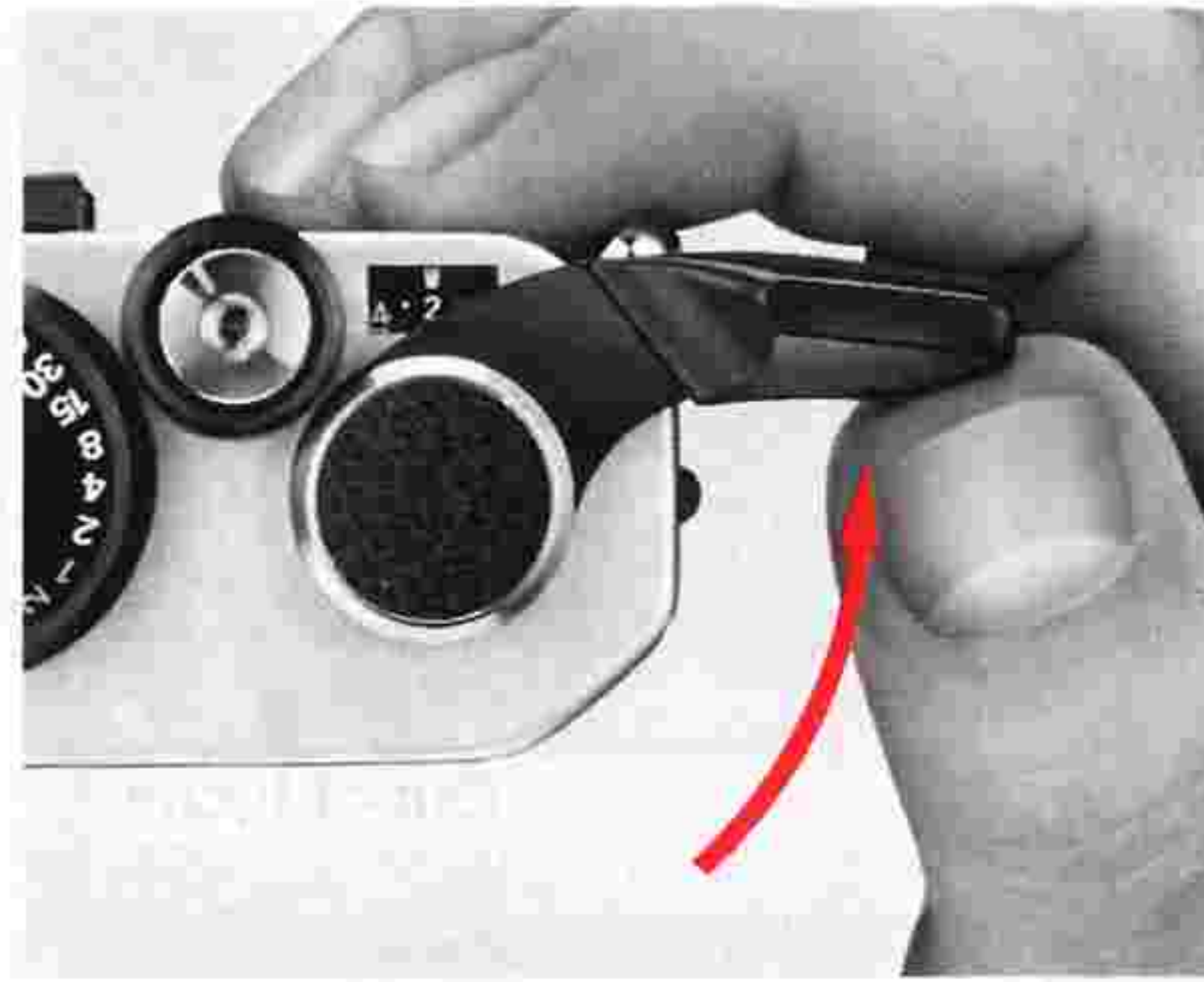
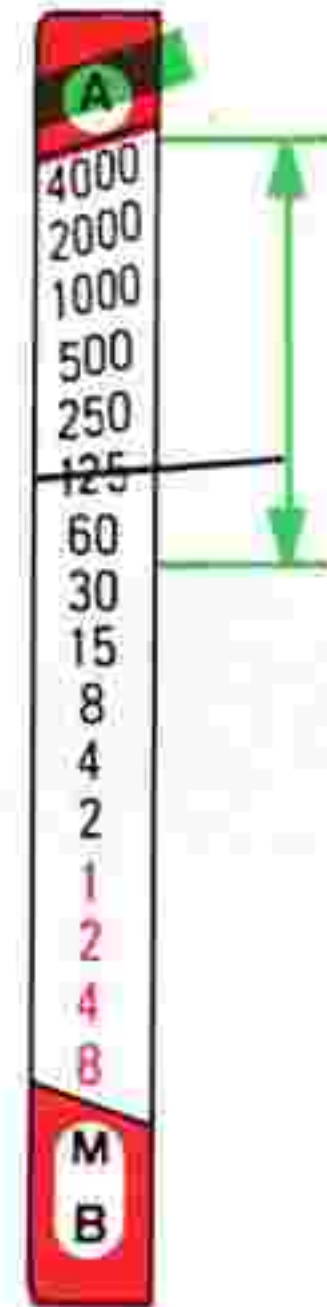
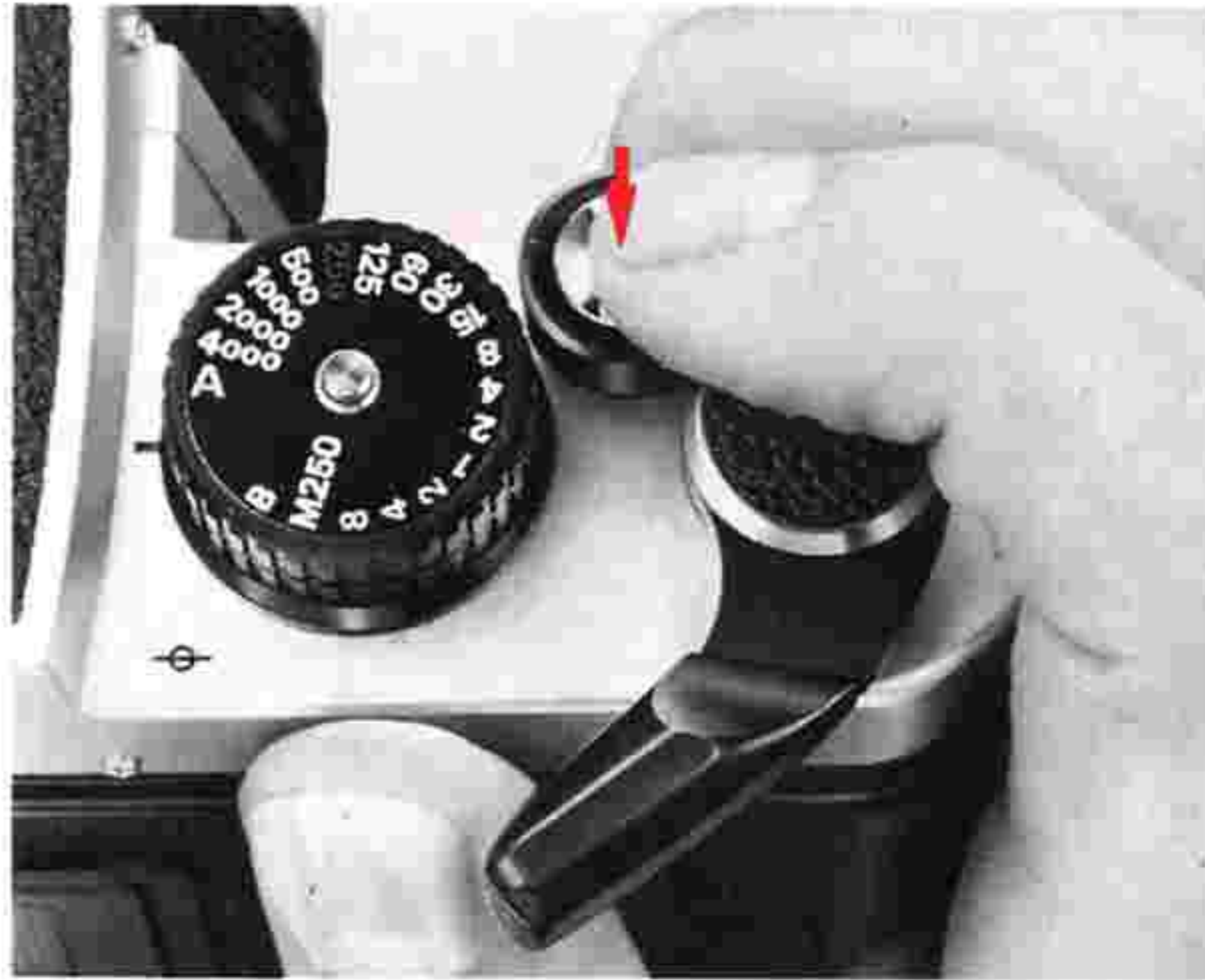

## 20. Take the photograph.

Look through the viewfinder and depress the shutter release button halfway. The shutter speed, in accordance with the subject brightness, is then indicated inside the viewfinder by the black meter needle. If the shutter speed needle points above 1/30 sec., depress the shutter release button all the way. If the shutter speed is 1/30 sec. or below, turn the aperture ring on the lens to make the speed at least above 1/30 sec. If you cannot obtain such a speed, refer to page 24.

### Notes:

- 1) A blurred photo may result if you take the shot at a shutter speed between 1/30 sec. and 8 sec.
- 2) If the black meter needle is on either of the red exposure warning marks, the shutter speed is out of the metering range. In this case, you cannot obtain the correct exposure. See page 24 for more details.

## 21. Advance the film.

Wind the film advance lever as far as it will go to transport the film to the next frame and ready the camera for the next shot. Do not apply excessive pressure in winding the lever.

**Note:** Don't press the film rewind button , or certain frames may be double exposed.



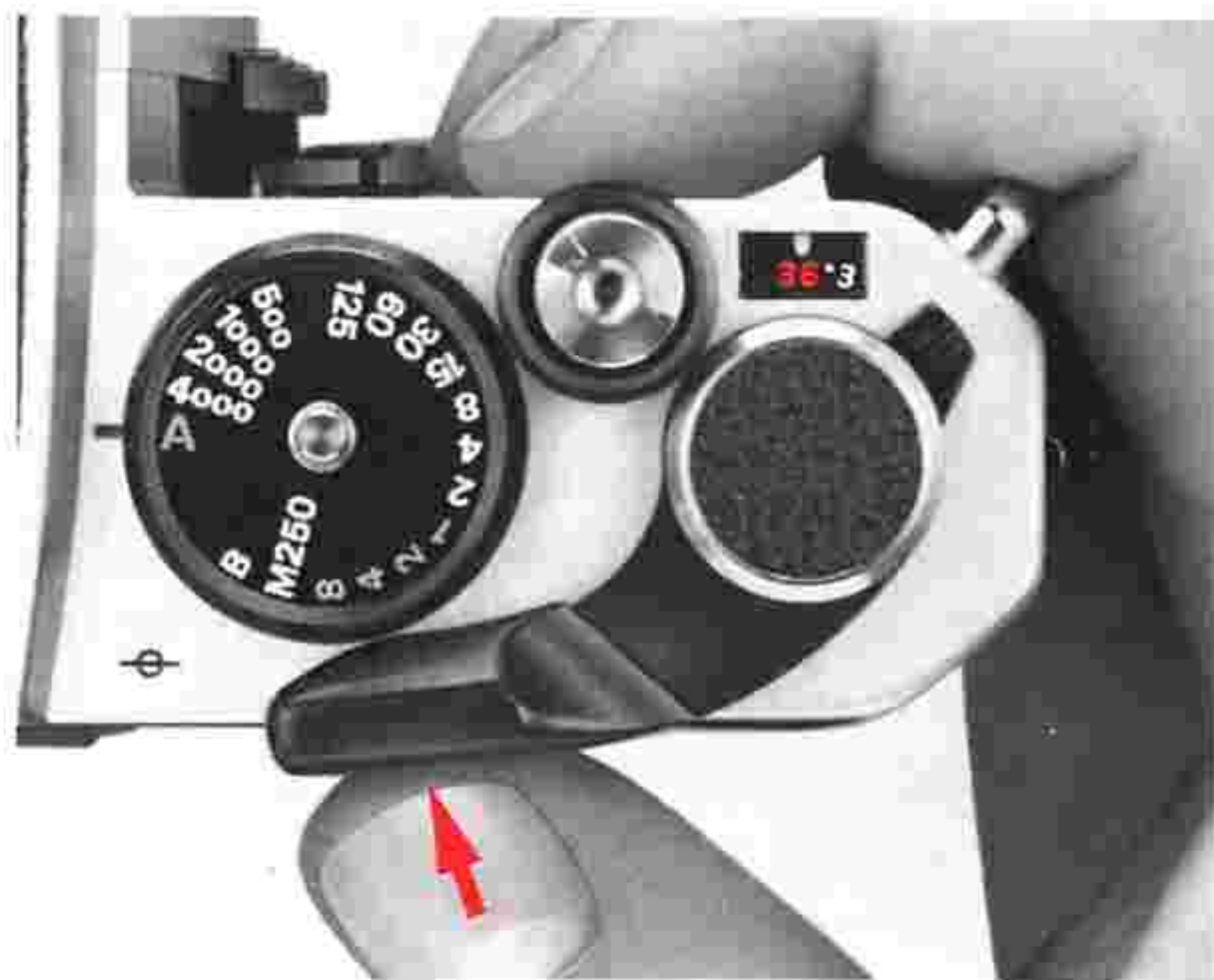

## 22. Push the film advance lever back into place.

After the last exposure has been made, the film advance lever won't move. Then push the film advance lever flush against the camera body. By so doing the shutter release button is locked and keeps the exposure meter switched off. This action prevents inadvertent shutter release.

**Note:** Even if the black meter needle remains inside the shutter speed scale after the meter switch is off, it will automatically be switched off in approx. 16 sec., and the exposure measuring circuit will simultaneously be cut off.

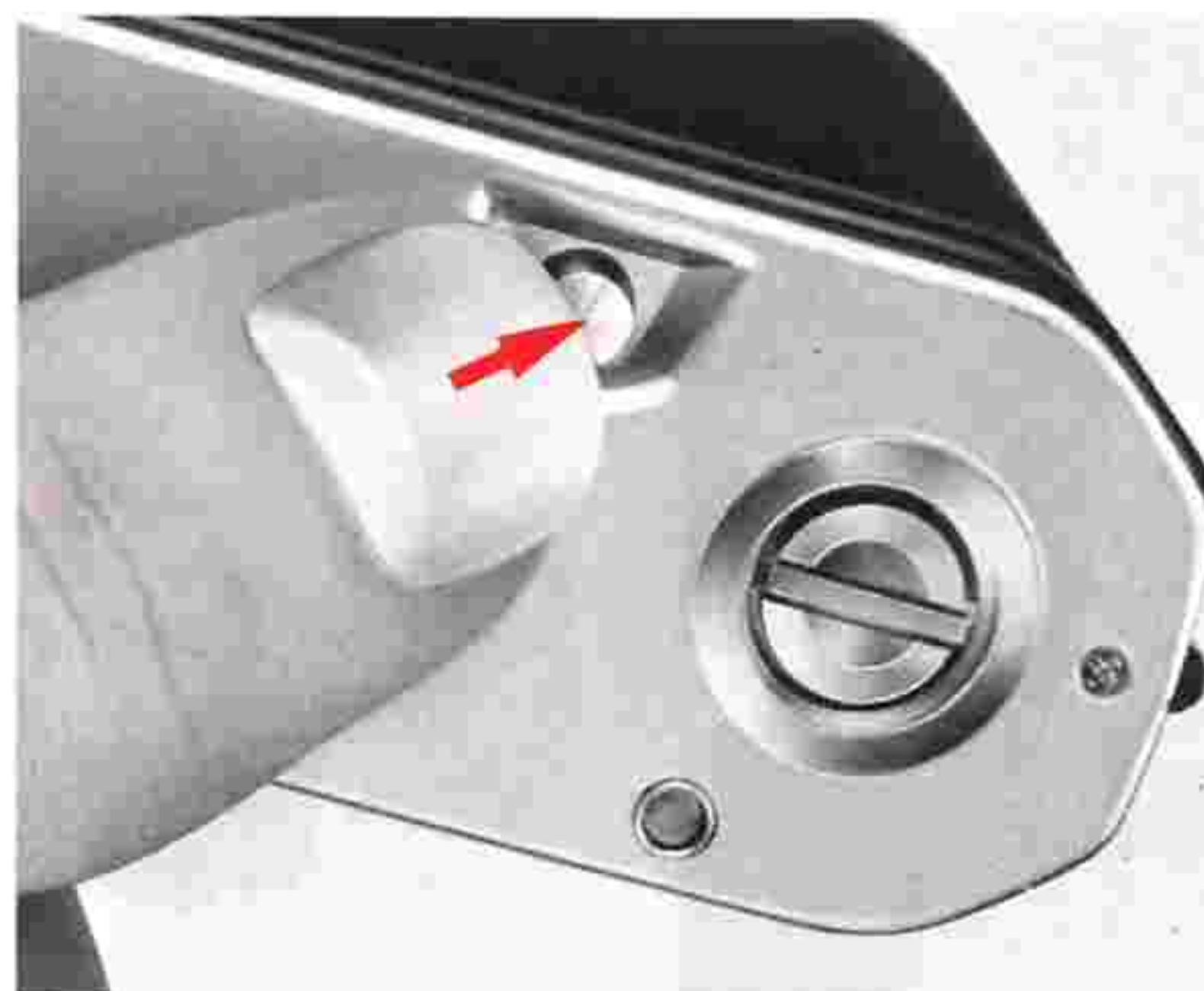

## 23. Press the film rewind button.

To rewind the exposed film back into the film cartridge, turn the camera upside down and press the film rewind button. You don't have to depress the button all the way.

## BASIC OPERATION—continued

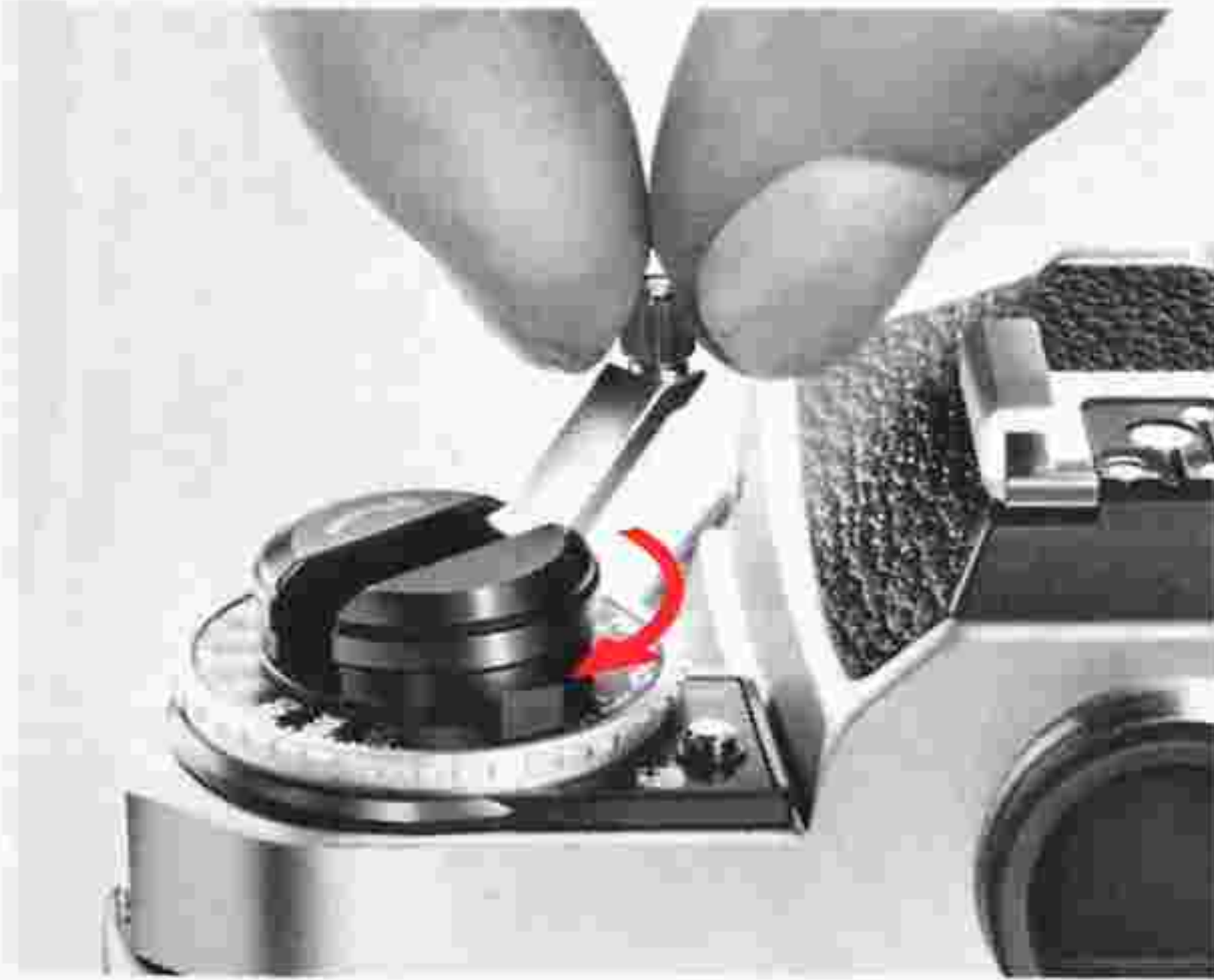

### 24. Rewind the film.

Fold out the film rewind crank and turn it gently in the direction of the arrow until you feel an increase in tension. Give it a few more turns until the tension is gone and the crank turns freely, indicating the film leader is rewound completely back into the cartridge.

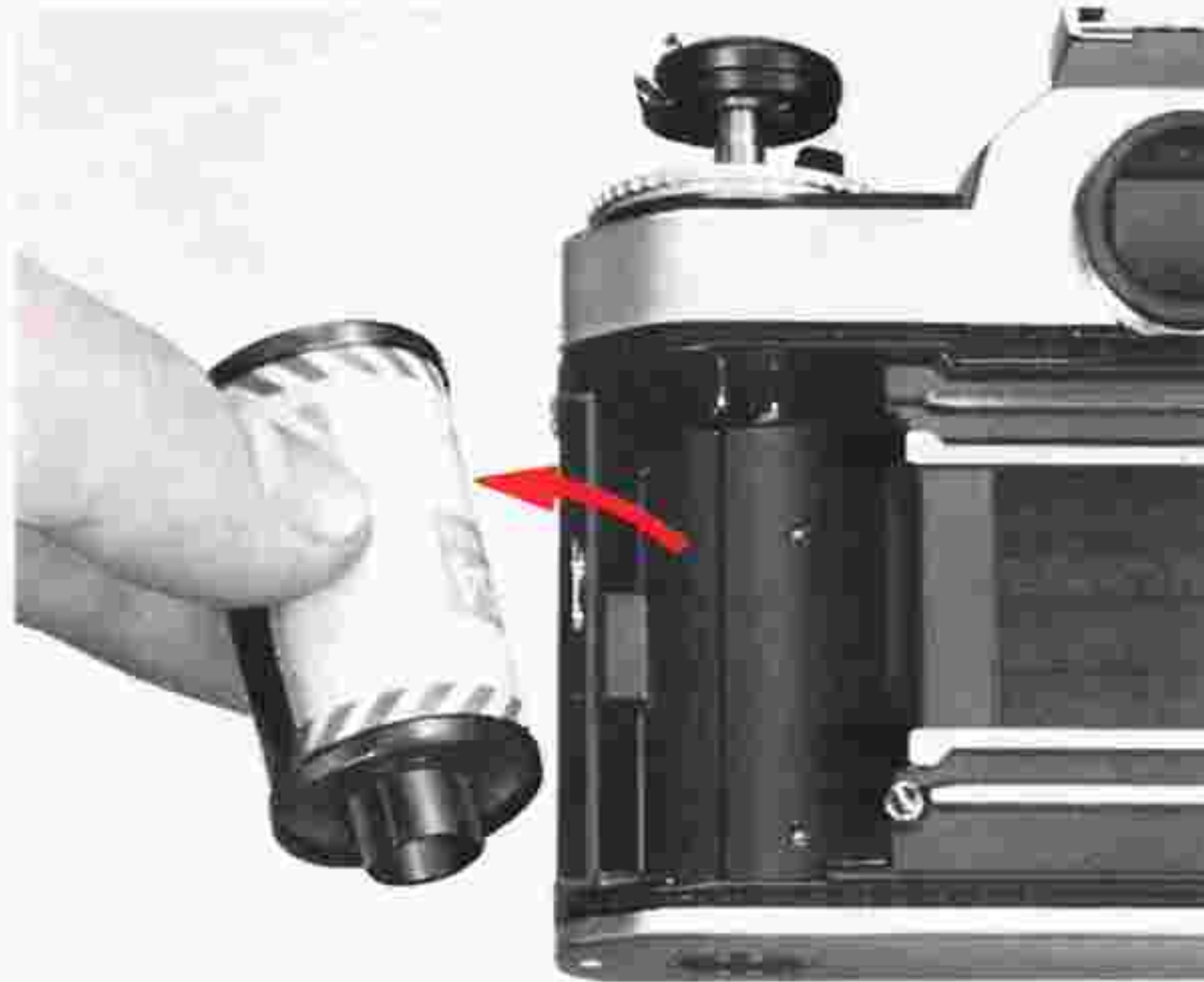

### 25. Remove the film cartridge.

Open the camera back by pulling up the rewind knob and take out the film cartridge. Avoid unloading in direct sunlight. If there is no shade available, turn your back to the sun and use your own shadow to shield the camera.

**Note:** Do not open the camera back before film rewinding is completed.

# IMPORTANT!

The Nikon FE2 is an AI-type (Automatic Maximum Aperture Indexing) camera which performs full-aperture metering with AI-type lenses such as AI-Nikkor and Nikon Series E lenses. The aperture rings of these lenses are fitted with meter coupling ridges ⑳ (see illustration 1). Almost all lenses now manufactured by Nikon are the AI-type. However, please confirm whether or not your lens is AI before using it with the FE2. AI-Nikkor lenses are identified by the two holes in the meter coupling shoe ㉑ (see illustration 2).

Although almost all Nikkor lenses that have the Nikon bayonet mount, as well as Nikon Series E lenses, can be mounted on the FE2, the camera cannot be used with Nikkor lenses that have not yet been modified to offer the AI facility nor with a few special-purpose lenses, because the FE2's meter coupling lever is fixed and the FE2 does not have a mirror lock-up mechanism. For particulars, refer to the table below.

Lens	Reason	Remarks
Fisheye-Nikkor 6mm f/5.6	Requires mirror up	Not usable.
Fisheye-Nikkor 10mm f/5.6 OP	Requires mirror up	Not usable
PC-Nikkor 28mm f/4	Hits camera's meter coupling lever	Serial No. 180901 and higher usable
PC-Nikkor 35mm f/2.8	Hits camera's meter coupling lever	Serial No. 906201 and higher usable Serial No. 851000 and lower usable
Reflex-Nikkor 1000mm f/11	Hits camera's meter coupling lever	Serial No. lower than 142361 and higher than 143000 usable
Reflex-Nikkor 2000mm f/11	Hits camera's meter coupling lever	Serial No. 200311 and higher usable
Zoom-Nikkor 200-600mm f/9.5	Hits camera's meter coupling lever	Serial No. 300491 and higher usable
Zoom-Nikkor ED 180-600mm f/8	Hits camera's meter coupling lever	Serial No. 174167 and higher usable
Zoom-Nikkor ED 360-1200mm f/11	Hits camera's meter coupling lever	Serial No. 174088 and higher usable
Focusing Unit AU-1	Hits camera's meter coupling lever	Not usable
Other Nikkor lenses that have not been modified to offer the AI facility	Hits camera's meter coupling lever	Requires AI modification

**Note:** The modification at reasonable cost of most non-AI lenses having a meter coupling prong is available for the convenience of Nikkor lens users. For further information concerning AI lens modification, please contact your local authorized Nikon dealer.

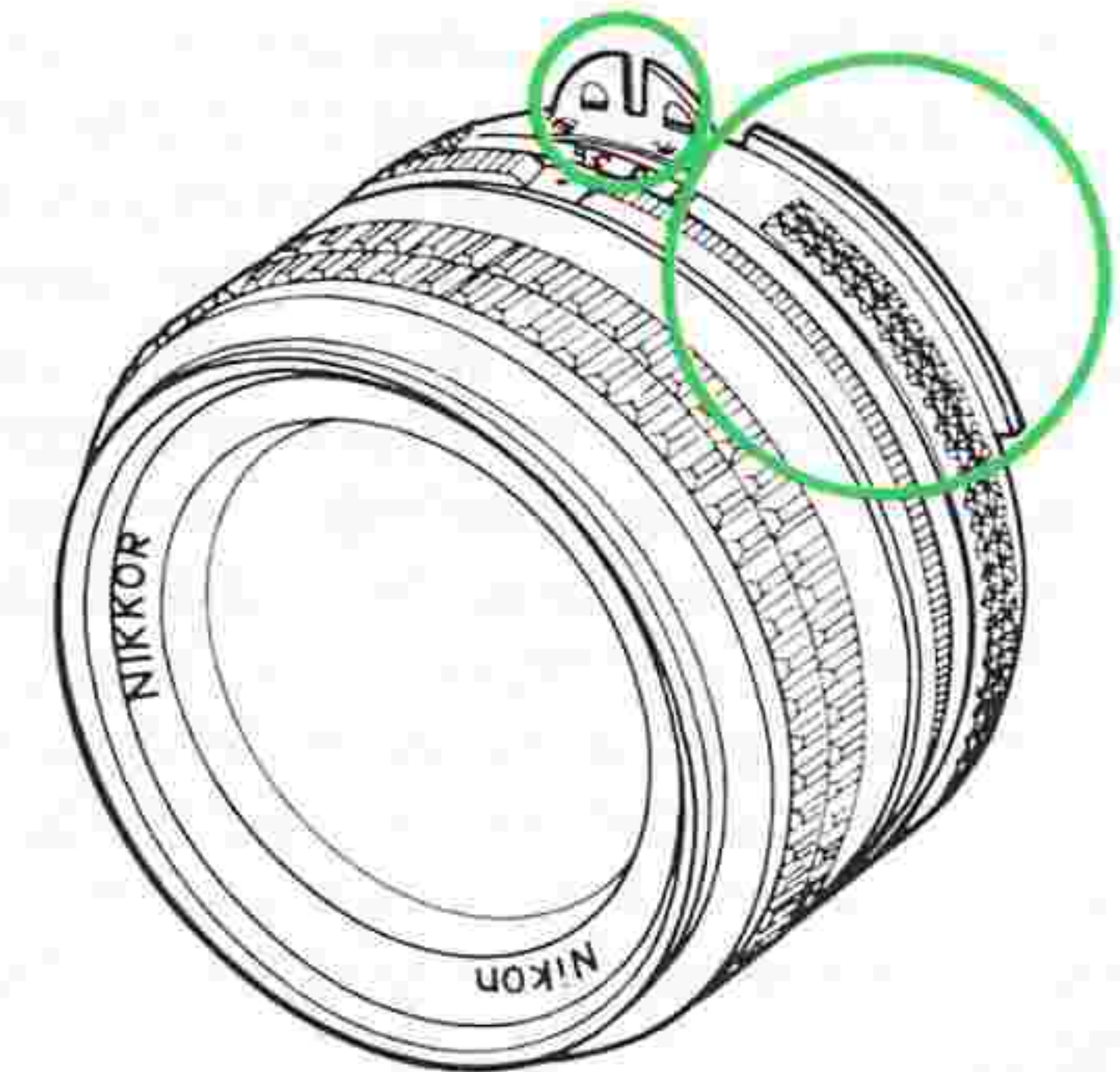
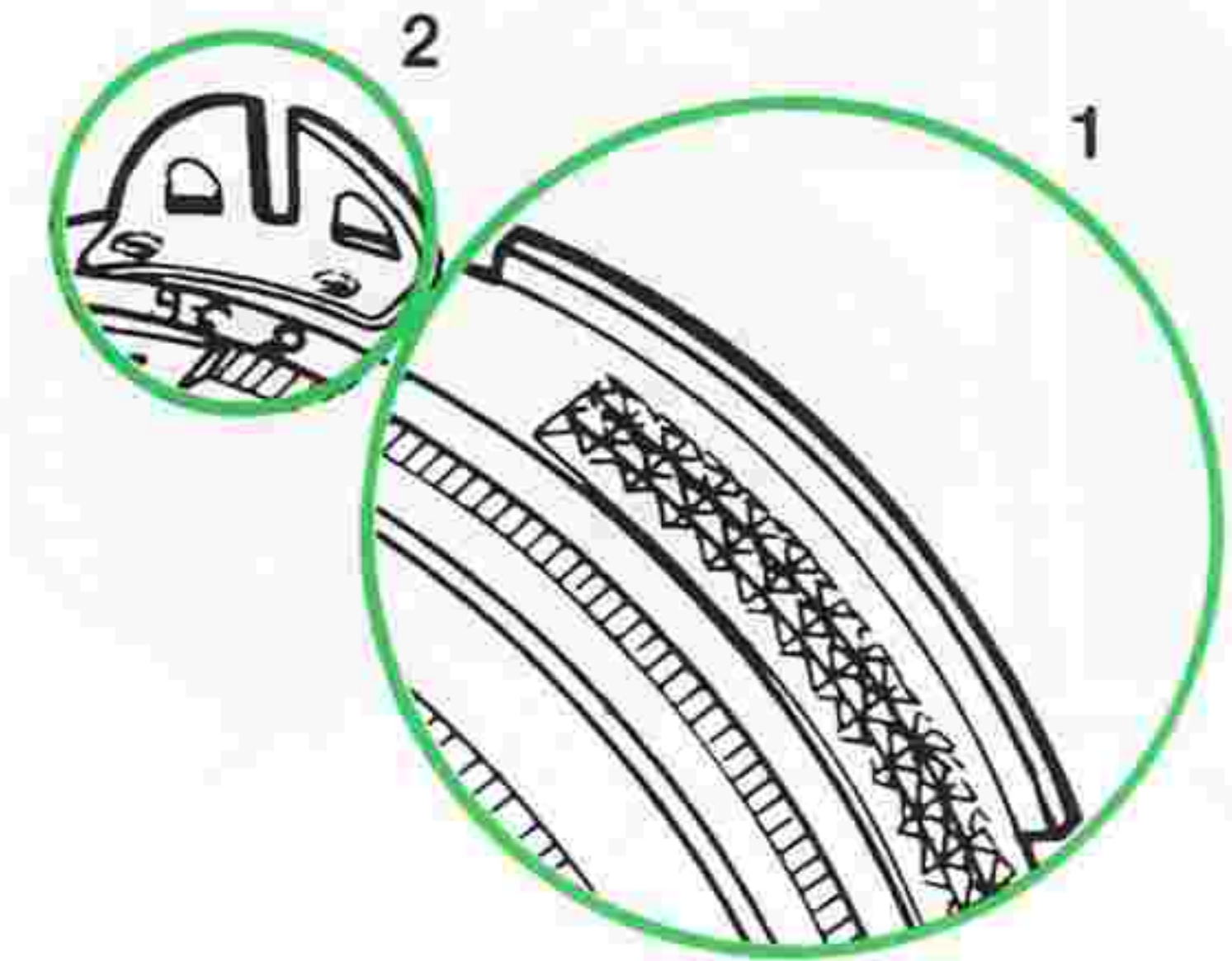

AI-Nikkor Lens

# CONTROLS IN DETAIL



## Shutter Speed/Mode Selector Dial ⑱

The Nikon FE2 offers aperture-priority automatic mode operation and manual control of all shutter speeds from 8 to 1/4000 sec., including the M250 (mechanically controlled—1/250 sec.) and B (bulb) settings. To set the desired shooting mode or shutter speed, rotate the shutter speed/mode selector dial until the desired setting click-stops opposite the shutter speed/mode index. At the A setting, a locking mechanism is provided to prevent accidental shifting of the setting. To rotate the dial from the A setting, depress the lock button ① provided. Note that shutter speeds between engraved numbers (i.e., intermediate speeds) cannot be used. Since you can see the shutter speed in use inside the viewfinder, it's not necessary to look at the shutter speed dial as you turn it. The dial has the following settings:

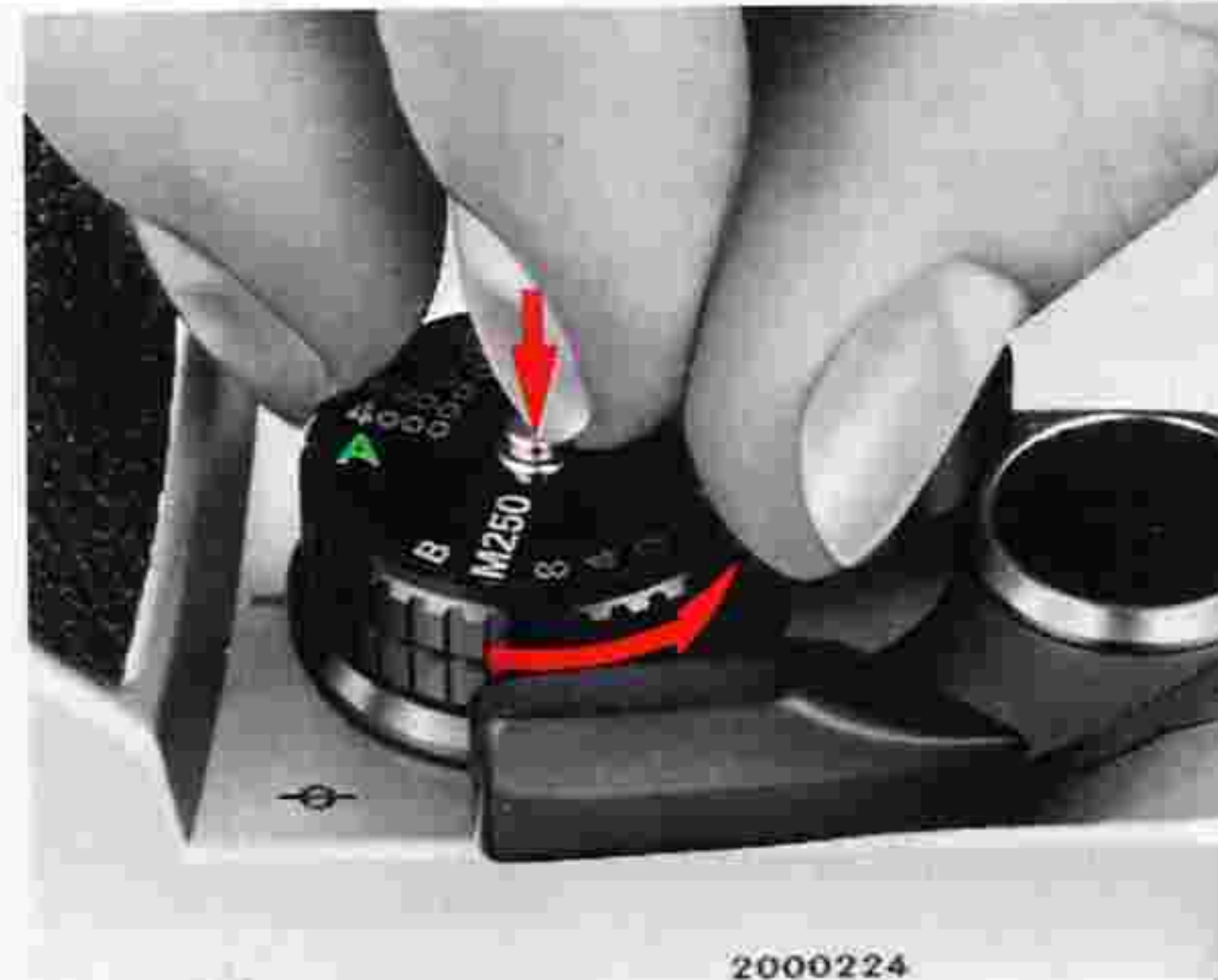

### **A (Auto):**

Used for aperture-priority automatic mode shooting. You manually set the f/stop first; then the camera automatically selects the matching electronically controlled shutter speed steplessly between 8 and 1/4000 sec., depending on the scene brightness and the film speed in use.

### **1/4000—8 sec. (Manual):**

Used for full manual control of both f/stop and shutter speed. All sixteen speeds indicated on the dial are available with timing accuracy assured by a quartz oscillator. Yellow numbers on the dial indicate actual shutter speeds, while white ones are reciprocals, i.e., 2 means 1/2 sec., and 4000 means 1/4000 sec. The 250 is indicated with red which means the fastest sync speed for an electronic flash unit. A one-stop change will either halve or double the exposure; e.g., a shutter speed of 1/125 sec. lets in twice as much light as a setting of 1/250 sec. and half as much light as 1/60 sec.

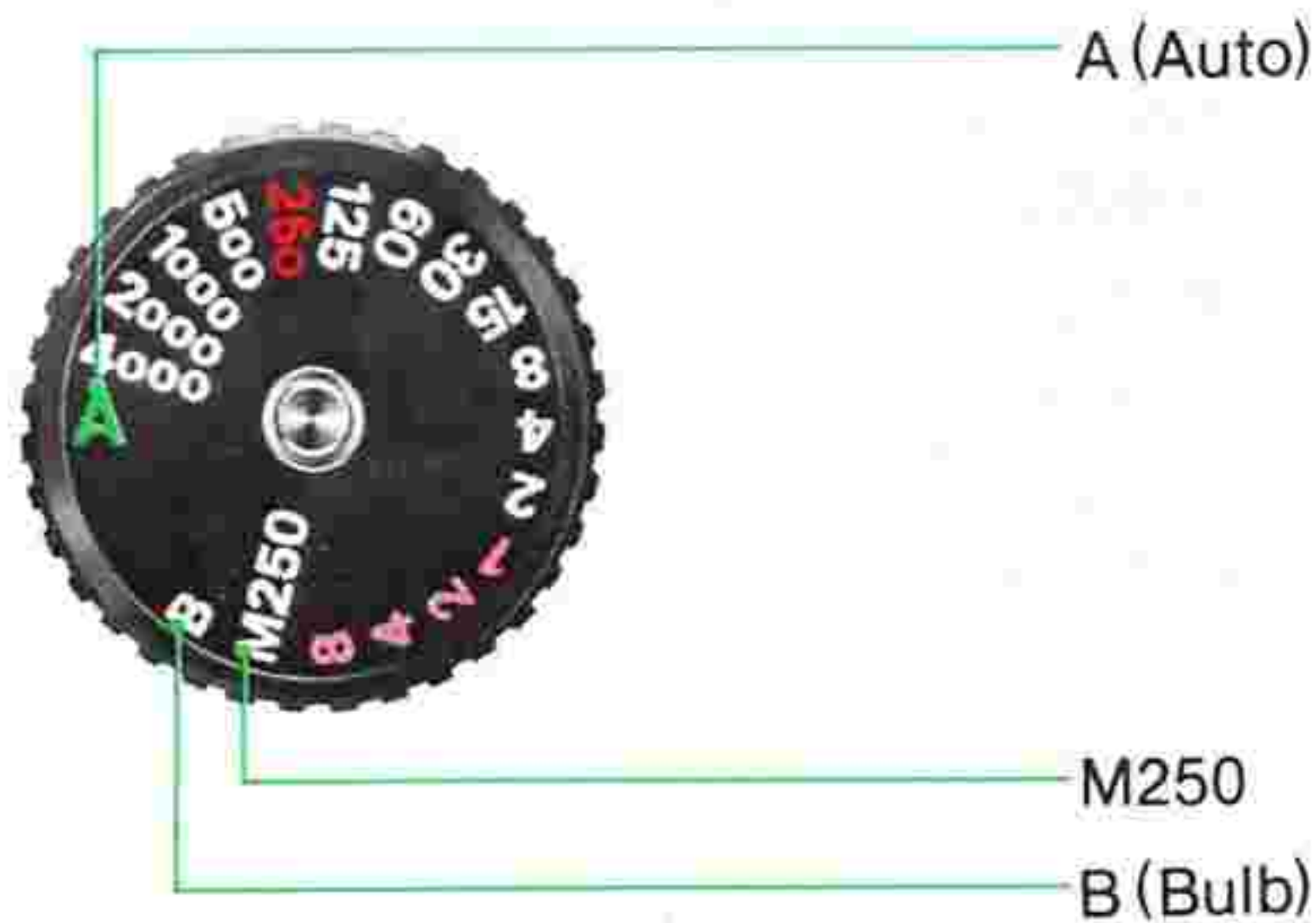

### **M250 (Mechanical—1/250 sec.):**

At this setting, the shutter operates mechanically at 1/250 sec.; this is used when the battery is exhausted and other shutter speed modes are not operable.

### **B (Bulb):**

At this mechanical setting, the shutter curtains ⑭ remain open as long as you depress the shutter release button. B is especially useful for making long time exposures with a cable release and a tripod.

### **Exposure metering system**

The Nikon FE2 employs a through-the-lens (TTL) center-weighted full aperture exposure metering system which measures the light passing through the lens at maximum aperture, thus assuring a bright finder image during shooting. Exposure measurement emphasis is placed especially on the brightness in the 12 mm dia. central area, although the meter reads the light over the entire focusing screen. Correct exposure is assured when the main subject is placed in this central area.

# CONTROLS IN DETAIL—continued

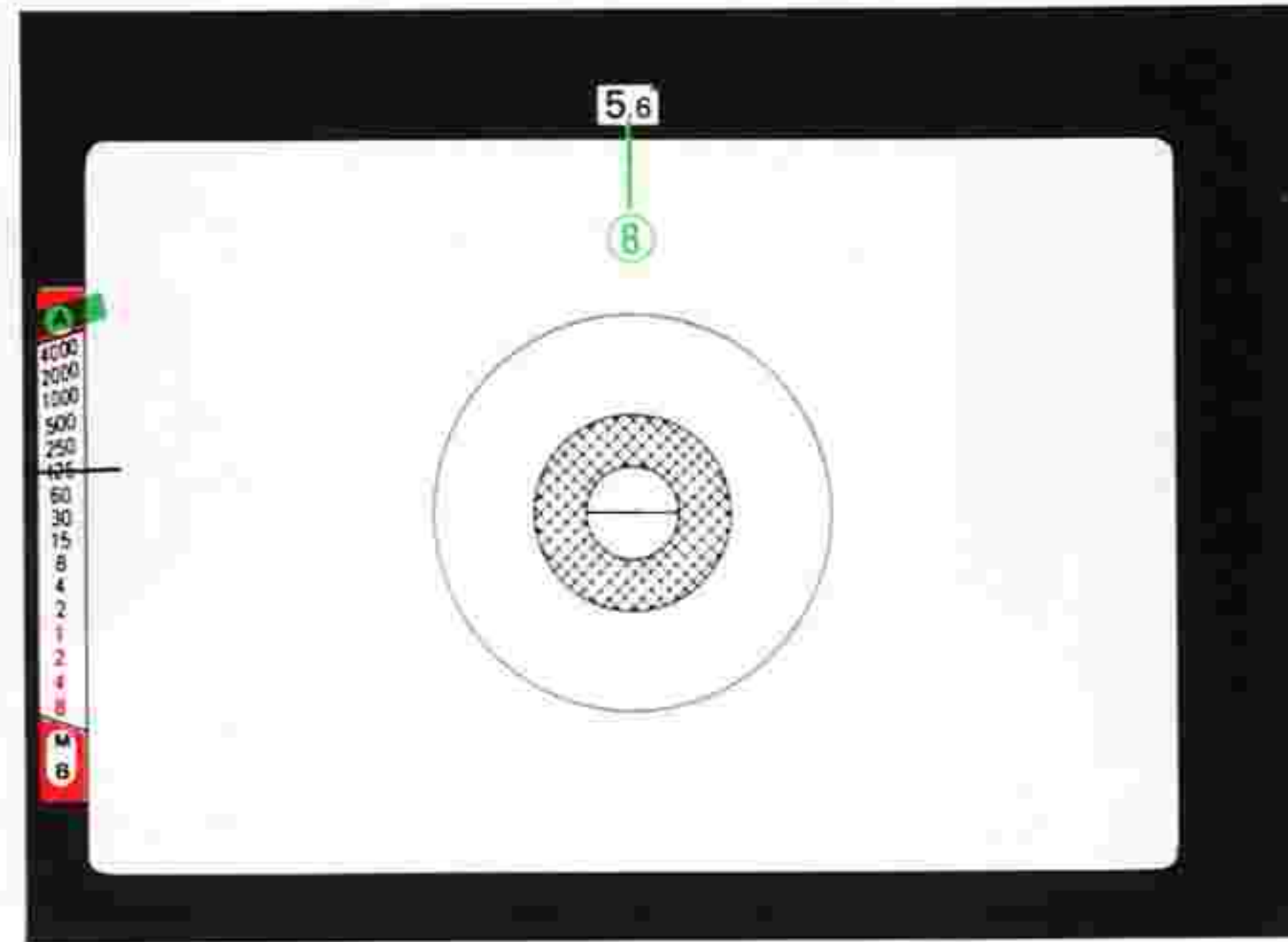
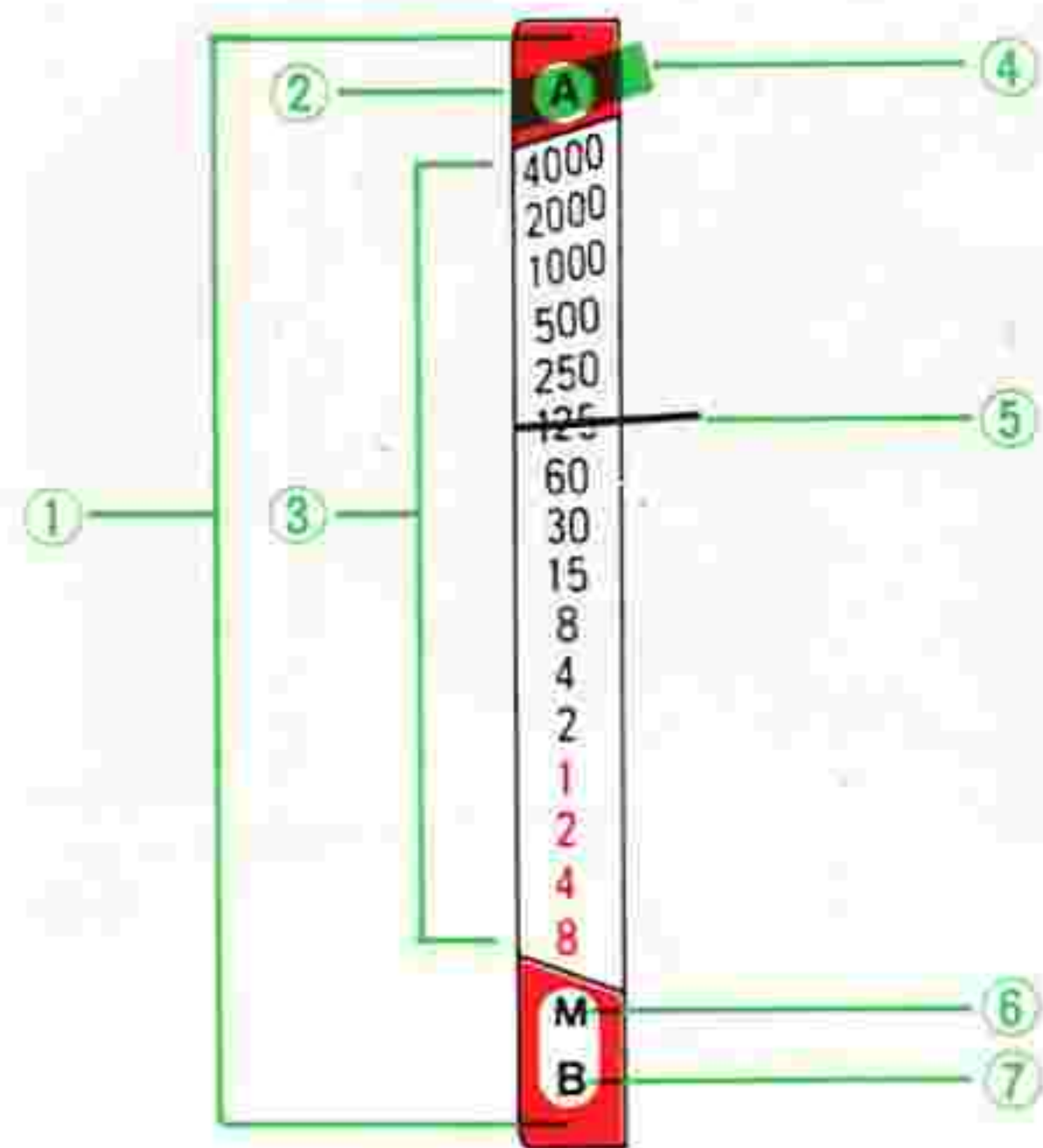

- ① Outside-exposure-range warning marks
- ② A (Auto)
- ③ Shutter speed scale
- ④ Shutter speed/mode indication needle
- ⑤ Meter needle
- ⑥ M250
- ⑦ B (Bulb)
- ⑧ f-number in use

## Exposure indications

The exposure indications appearing on the shutter speed/mode scale at the left-hand side of the viewfinder indicate the necessary information for the correct exposure. Also the f/stop in use appears through the ADR window ⑧ above the viewfinder frame.

## Meter needle

As soon as the shutter release button is depressed halfway to switch on the meter, the black needle automatically swings up to show the correct shutter speed, according to the subject brightness and the f/stop set on the lens. Please note that the needle doesn't move before the frame counter reaches frame "1" or when the shutter speed/mode selector dial is set at M250 or B.

## Shutter speed/mode indicator needle

This green needle moves accordingly as you turn the shutter speed/mode selector dial. For example, turn the shutter speed/mode selector dial to A and the indication moves to the A position to indicate automatic operation.

## Outside-exposure-range warning marks

Both the upper and lower portions of the shutter speed scale are in red to indicate an exposure that is outside the meter's range. If the black meter needle is located in either of these red areas after metering, adjust the f/stop on the lens until the needle moves out of these areas.

For more information refer to page 24.

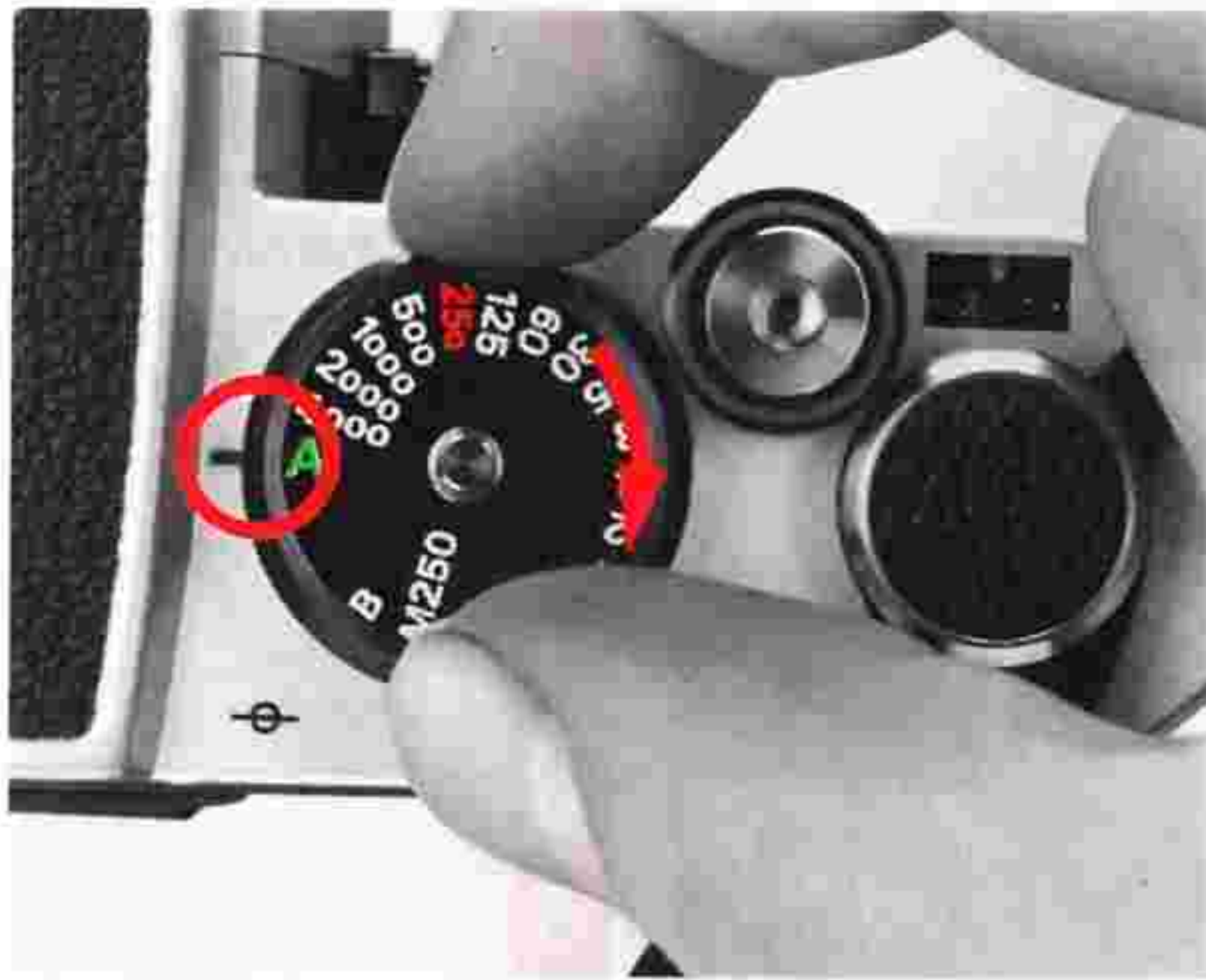

## Automatic exposure photography— aperture priority shooting

With the FE2 set at A, you select the f/stop and the electronically controlled metering circuit matches it with the correct stepless shutter speed. The A mode is especially useful, because it allows you to control depth of field while using the camera on automatic to assure perfect exposure. Deeper depth of field (or a greater zone of sharp focus in front of and behind the main subject) is achieved as you stop down the lens to smaller apertures (indicated by numerically larger f-numbers). Shallower depth of field (where the focus is restricted to the main subject) results when larger apertures are used. (Refer to page 38 for more information.)

### Shooting on auto

- 1) Set the shutter speed/mode selector dial at A.
- 2) Set the desired f/stop on the lens.
- 3) Look through the viewfinder and place the main subject in the center of the frame.
- 4) Pull out the film advance lever and depress the shutter release button halfway.
- 5) Confirm the position of the meter needle. If the shutter speed is above 1/30 sec., but not over 1/4000 sec., depress the shutter release button all the way. The correct exposure will be obtained.

# CONTROLS IN DETAIL—continued

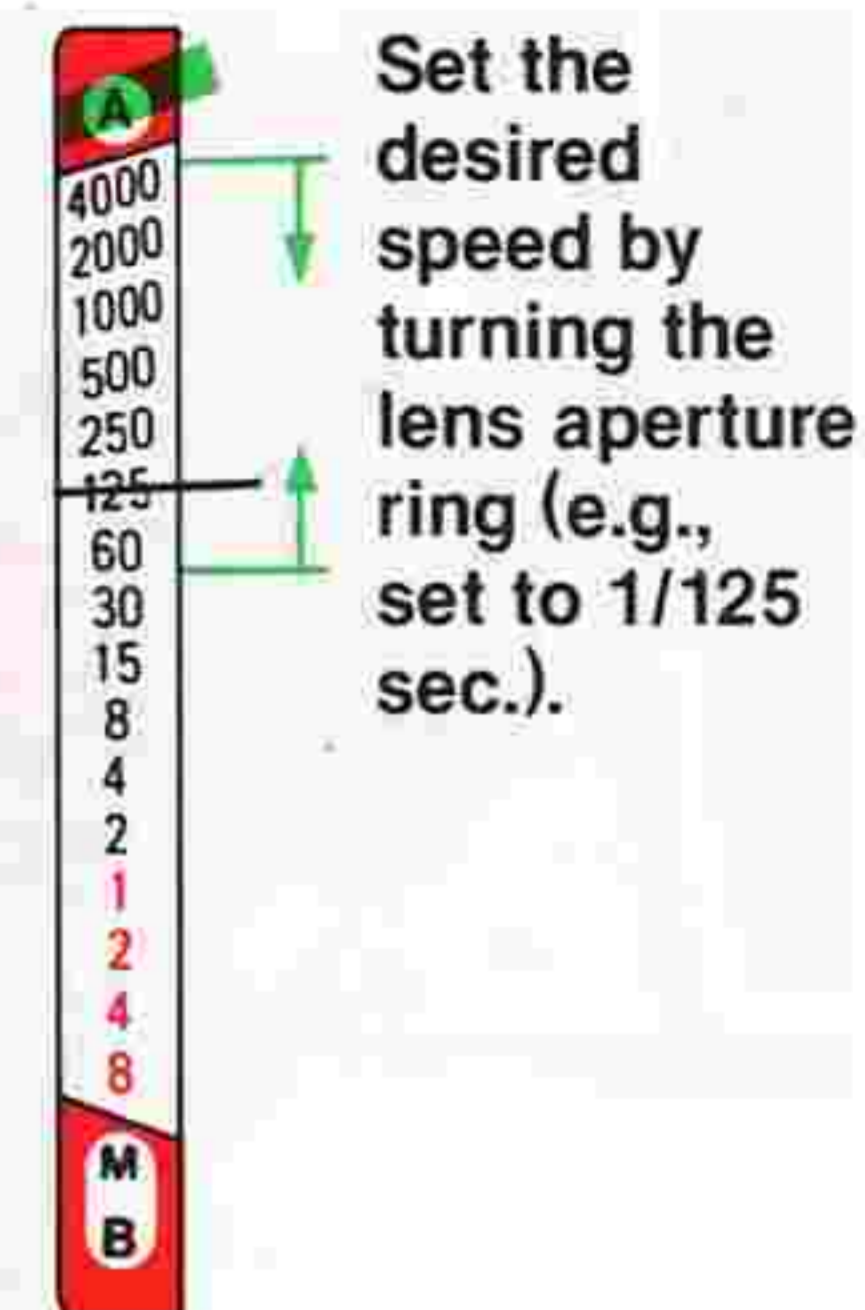
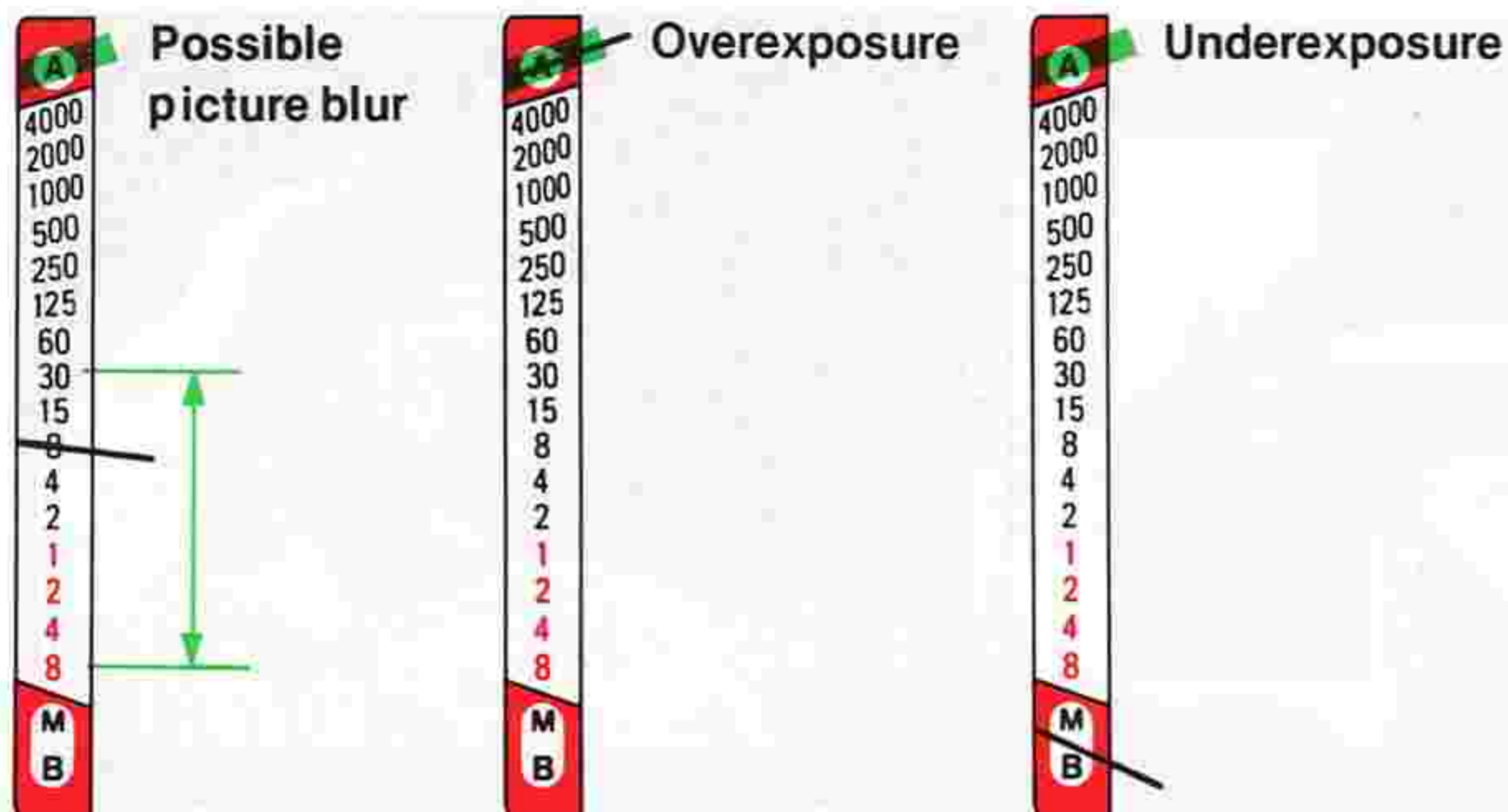

Set the desired speed by turning the lens aperture ring (e.g., set to 1/125 sec.).

- When the meter needle is between 1/30 and 8 sec. the picture will probably come out blurred if you attempt to take the shot while hand holding the camera. In this case, turn the aperture ring to obtain a larger aperture. If after opening up the lens all the way, the shutter speed does not go above 1/30 sec., use a tripod to steady the camera. As alternatives, use electronic flash or change to a higher speed film.
- If the meter needle is in the upper warning area, use a smaller aperture. If, after you have stopped the lens down all the way and the needle still remains in this area, use a neutral density filter or change to a slower speed film.
- If the meter needle is in the lower warning area, use a larger aperture. If, after you have opened the lens up all the way and the needle still remains in this area, use electronic flash or switch to the B setting to make a time exposure.

## Automatic exposure photography— Shutter priority shooting

For shooting moving subjects, the FE2 also enables you to select the shutter speed on Auto either to freeze the action and produce sharp outlines with a faster shutter speed, or to cause an intentional blur by choosing a slower shutter speed. To operate the FE2 in this way, depress the shutter release button halfway; then match the meter needle with the speed you desire by turning the lens aperture ring.



## Manual exposure photography

Manual operation allows you to shoot at your choice of any combination of f/stop and sixteen speeds on the camera's dial. By varying these combinations, you can achieve not only correct exposure but also such special effects as under- or over-exposure, blurred action, etc. Manual is also valuable in developing your photographic skills, and is additionally recommended when an electronic flash other than the Nikon dedicated flash unit is used. B and M250 settings also offer manual exposure photography.

## How to select the f/stop and shutter speed

Exposure is determined by the combination of shutter speed and aperture. As the numbers on either the aperture ring or shutter speed dial increase by one increment, the amount of light striking the film is reduced by approximately one half. For example, the amount of light at 1/125 sec. is one half that at 1/60 sec., and the amount of light at f/16 is one half that at f/11. Brighter scenes require either faster speeds or smaller apertures or a combination of both which will give the same amount of exposure; darker scenes require the reverse. For example, 1/1000 sec. at f/5.6 is the same as either 1/4000 sec. at f/2.8 or 1/125 sec. at f/16.

## Shutter speed/aperture combinations that give the same exposure

Shutter speed (sec.)	1/4000	1/2000	1/1000	1/500	1/250	1/125
Aperture (f/number)	2.8	4	5.6	8	11	16

# CONTROLS IN DETAIL—continued

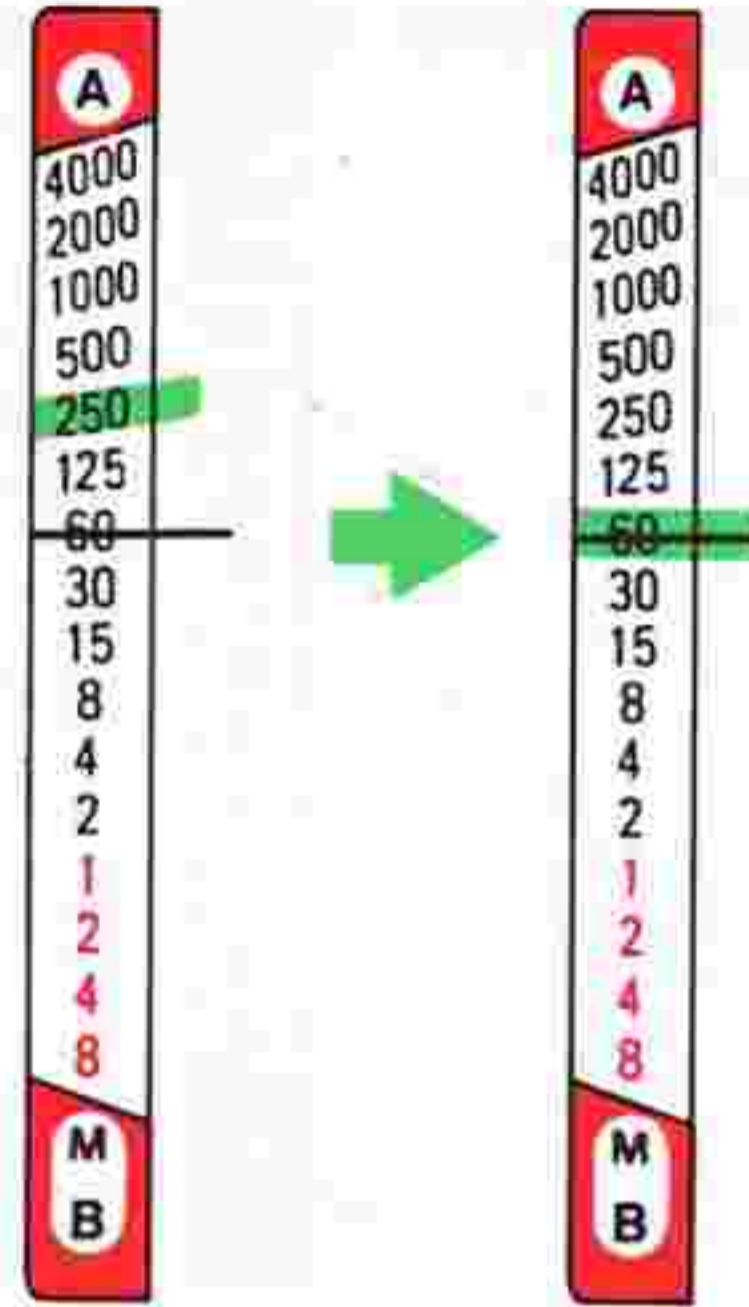
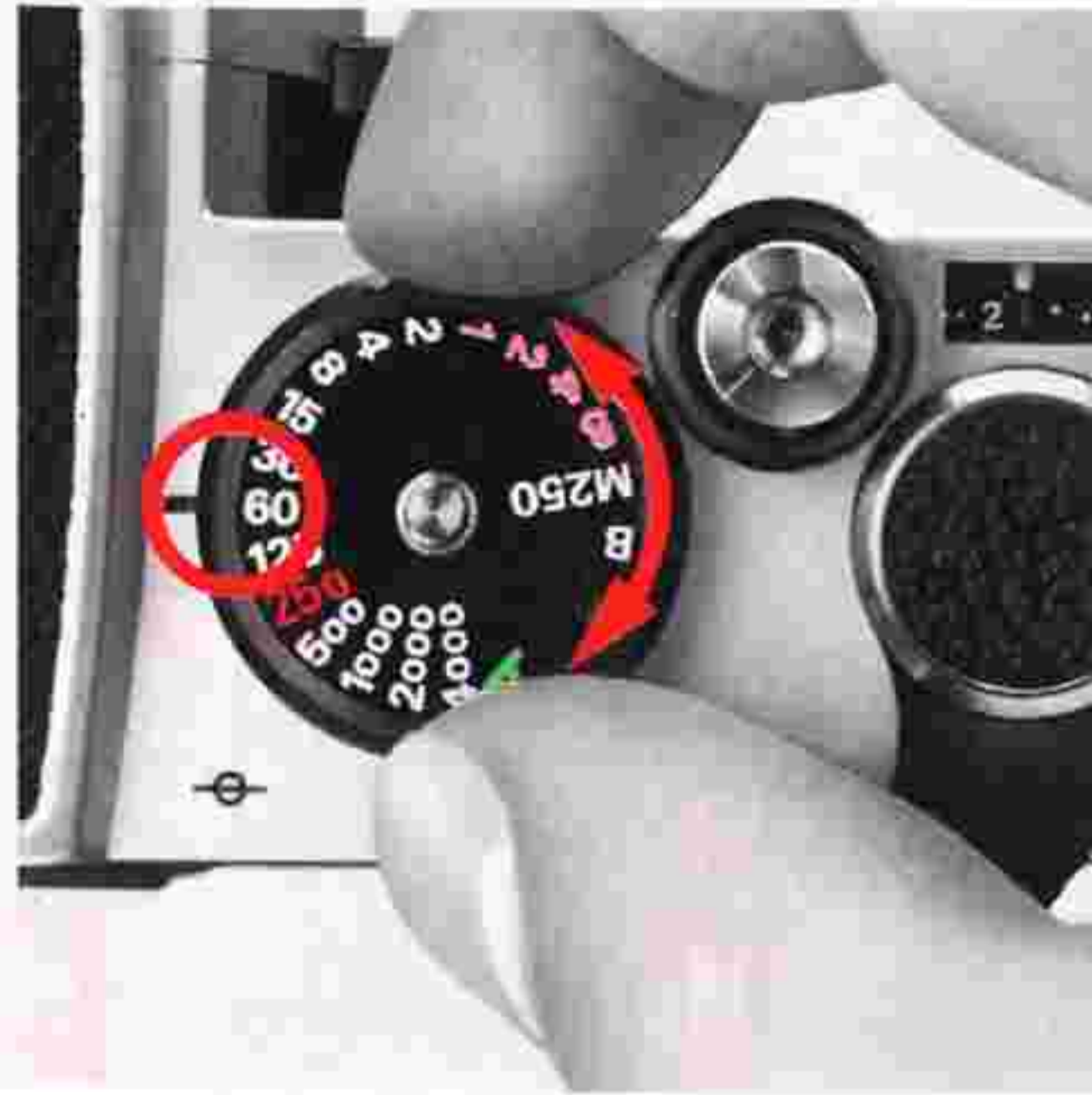

## Shooting on manual

- 1) Turn the shutter speed/mode selector dial to any of sixteen numbered settings or set the f/stop you desire. Faster shutter speeds will freeze moving subjects while slower ones cause the action to blur. (Note that you cannot use the shutter speed/mode selector dial in between the indicated settings.)
- 2) While looking through the viewfinder, place the subject in the center of the frame; then pull out the film advance lever, depress the shutter release button halfway, and check both the black meter needle and green shutter speed/mode indicator needle.
- 3) If both are apart, to get the correct exposure, rotate the aperture ring and/or the shutter speed dial so that they are aligned.
- 4) Depress the shutter release button all the way to take the picture.

## Notes:

- 1) Because the aperture ring can be set in between the engraved f-numbers, slight adjustment to obtain the correct exposure should be made by turning the aperture ring of the lens.
- 2) At the mechanical settings of M250 and B, the meter does not function and the meter needle will not move.
- 3) If you wish to create intentional under- or overexposure, set either the aperture ring or shutter speed/mode selector dial so that both needles in the viewfinder are not aligned.



A fast shutter speed freezes the action.

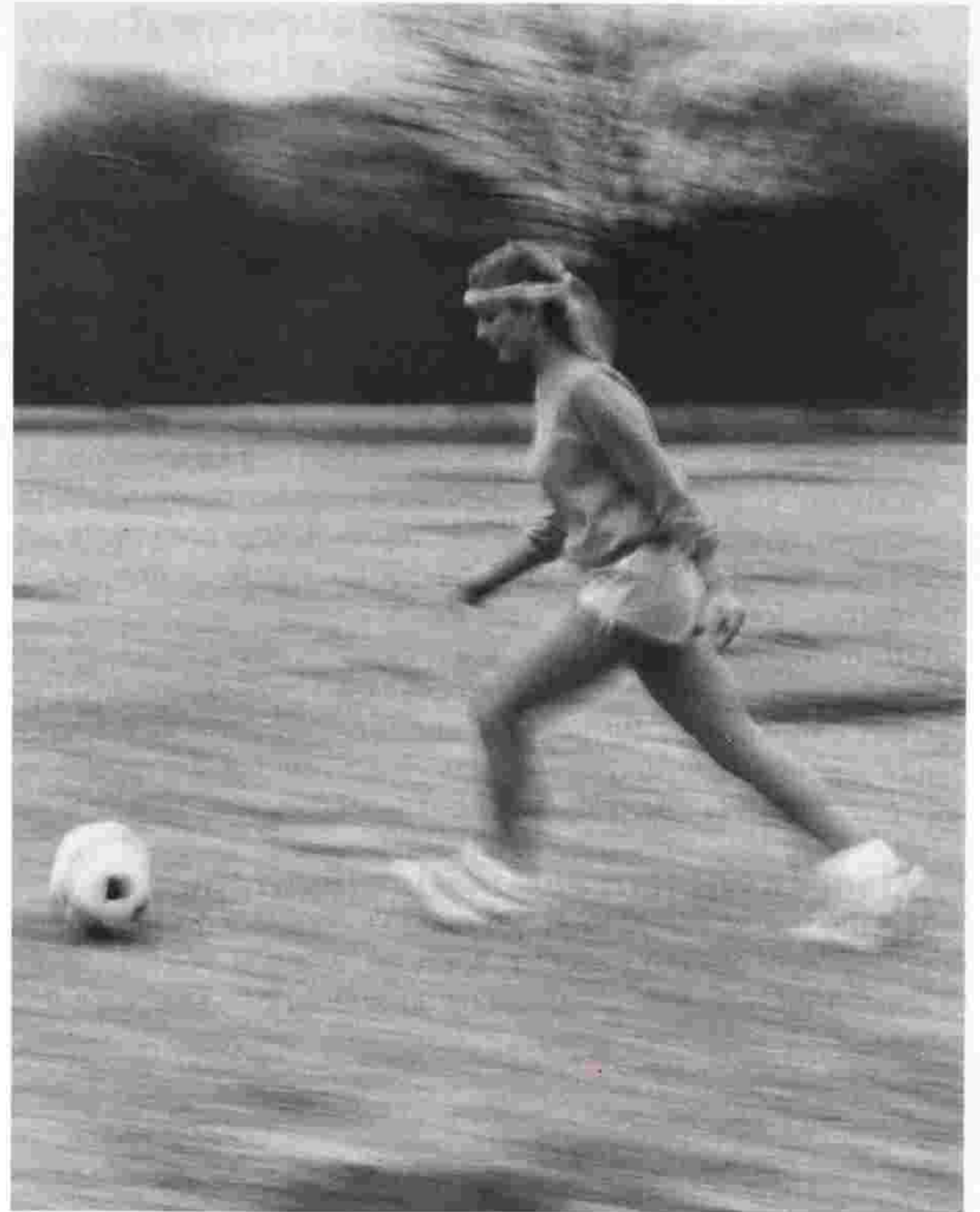

A slower speed allows everything to blur.

## Stop-Down Exposure Measurement

Stop-down exposure measurement must be made whenever the aperture ring of the lens doesn't couple with the meter coupling lever of the camera. After focusing and switching on the meter, follow these procedures:

### For lenses with automatic diaphragms

#### On auto:

Depress the depth-of-field preview lever ⑤ all the way and, while holding it in, take the shot.

Or depress the depth-of-field preview lever to take a meter reading. Then, while holding it in, push the self-timer lever ⑥ towards the camera body to lock in the exposure setting. With the exposure locked in, release the depth-of-field preview lever and take the shot. (Refer to page 37 for more details about the memory lock.)

#### On manual:

While holding in the depth-of-field preview lever, determine the correct exposure by turning the shutter speed/mode selector dial or the aperture ring of the lens. Then release the depth-of-field preview lever and take the shot.

### For lenses without automatic diaphragms

When the automatic diaphragm doesn't couple with the meter coupling lever of the camera, such as when a PC-Nikkor or bellows attachment is used, focusing should be done with the

lens wide open while exposure measurement and shooting must be done with the lens stopped down.

#### On auto:

Take a shot with the lens stopped down.

With a PC-Nikkor, the correct exposure must be determined before shifting. To do so, first use the memory lock, then the lens can be shifted to take the shot.

#### On manual:

Stop down the lens to determine the correct exposure, then take the shot.

### For lenses with fixed apertures

Since the aperture is fixed when using Reflex-Nikkor lenses, or in photomicrography or telescopic photography, it is impossible to change the exposure by varying the aperture.

#### On auto:

Take the shot by simply depressing the shutter release button.

#### On manual:

Turn the shutter speed dial to set the correct exposure. If a correct exposure can't be obtained, use either an ND filter if the scene is too bright or supplementary illumination if too dark.

#### Notes:

- 1) Keep the depth-of-field preview lever firmly depressed when you release the shutter.
- 2) If you attempt to make a stop-down exposure measurement when an AI lens is mounted directly on the FE2, incorrect exposure will result.

## EV Range of the Camera

The camera's meter may be used only within the shutter speed range covered by the exposure value (EV) range of the meter, which varies with the aperture and ASA/ISO setting.

The chart on page 31 shows the relationships between the f/stop, shutter speed and film speed, indicating the usable functioning shutter speed (for metering purposes) with any film speed/aperture combination.

Careful attention to the following instructions will assure precise exposure, automatically, over the complete exposure control and meter range capabilities of your Nikon FE2.

## What is EV?

Exposure value (EV) is a number representing the available combinations of shutter speed and aperture that give the same exposure effect when the scene brightness and ASA/ISO remain the same.

At ASA/ISO 100, a shutter speed of one second at f/1.4 is defined as EV 1. If the aperture is stopped down by one full f/stop or the shutter speed is one step faster, the EV increases by one; if the aperture is opened up by one full f/stop or the shutter speed is one step slower, EV decreases by one. Using ASA/ISO 100 as an example, 1 sec. at f/2 is EV 2, 1 sec. at f/5.6 is EV 5, while 1/125 sec. at f/5.6 is EV 12. As the exposure is the same, 1/30 sec. at f/11 and 1/1000 sec. at f/2 are also EV 12.

# CONTROLS IN DETAIL—continued

## How to read the EV chart

Section A of the chart shows the usable EV range depending on the lens' maximum aperture in full-aperture metering, while it also indicates the usable EV range for aperture settings in stop-down metering. Section D shows the value for the ASA/ISO film speeds, Section B the aperture settings for various film speeds, and Section C the shutter speeds. In practice, you will find that it is generally the high end and the low end of the metering range which require a careful check. The EV range of the Nikon FE2 encompasses most lighting situations, and it is only under very dim or very bright picture-taking situations that you need pay any special attention.

### ■ Full-aperture metering

Use the Nikkor 50mm f/1.4 lens and a film speed of ASA/ISO 100 as an example. By referring to the f/1.4 column in Section A and the EV value indicated for ASA/ISO 100 in Section D, you will find that the FE2's EV range in this case is 1 to 18.

If the lens is set at f/5.6, refer to Section B and single out the f/5.6 indication for ASA/ISO 100. Go diagonally down until the protruding line intersects with Section C's vertical line for a shutter speed of 8 sec. (the FE2's slowest shutter speed). From this point of intersection, follow the horizontal line that leads to Section D's EV value for ASA/ISO 100, and you will obtain an EV value of 2. Start again from the f/5.6 indication for ASA/ISO 100 in Section B, and go down diagonally until the protruding line intersects with Section C's vertical line for a shutter speed of 1/4000 sec. (the FE2's fastest shutter speed) this time. Then follow the horizontal line that leads to Section D's EV value for ASA/ISO 100, and you will get a reading of EV 17. This means that at an f/stop of f/5.6 at ASA/ISO 100 and at shutter speeds

from 8 to 1/4000 sec., the effective metering range is EV 2 to 17, which is well within the FE2's metering range of EV 1 to EV 18.

### ■ Stop-down metering

For stop-down metering, Section A indicates the usable EV range for various aperture settings. For example, if the lens is stopped down to f/8 at ASA/ISO 100, refer to the f/8 column in Section A and the EV values indicated for ASA/ISO 100 in Section D, and you will find that the EV range for f/8 is EV 6 to 23. Now single out f/8 at ASA/ISO 100 in Section B. Go diagonally down until the protruding line intersects with Section C's vertical line for the shutter speed of 8 sec. From this point of intersection, follow the horizontal line that leads to Section D's EV value for ASA/ISO 100, and you will obtain an EV reading of 3. This means that an f/stop of f/8 at ASA/ISO 100 and a shutter speed of 8 sec. give an EV value outside the metering range. To find out the slowest shutter speed usable, follow the f/8 indication for ASA/ISO 100 in Section B diagonally down until it intersects the horizontal line in Section C that leads to Section D's EV value of 3 for ASA/ISO 100, and you will find that the slowest shutter speed usable is 1 sec. In other words, at f/8 at ASA/ISO 100, the available shutter speed range is from 1 to 1/4000 sec., which has an effective EV range from EV 6 to 18 (indicated by the broken line in Section C)—well within the metering range.

These EV charts indicate the performance of the FE2 under normal temperatures and give the usable ranges for all shutter speed/film speed combinations.

# EV Chart

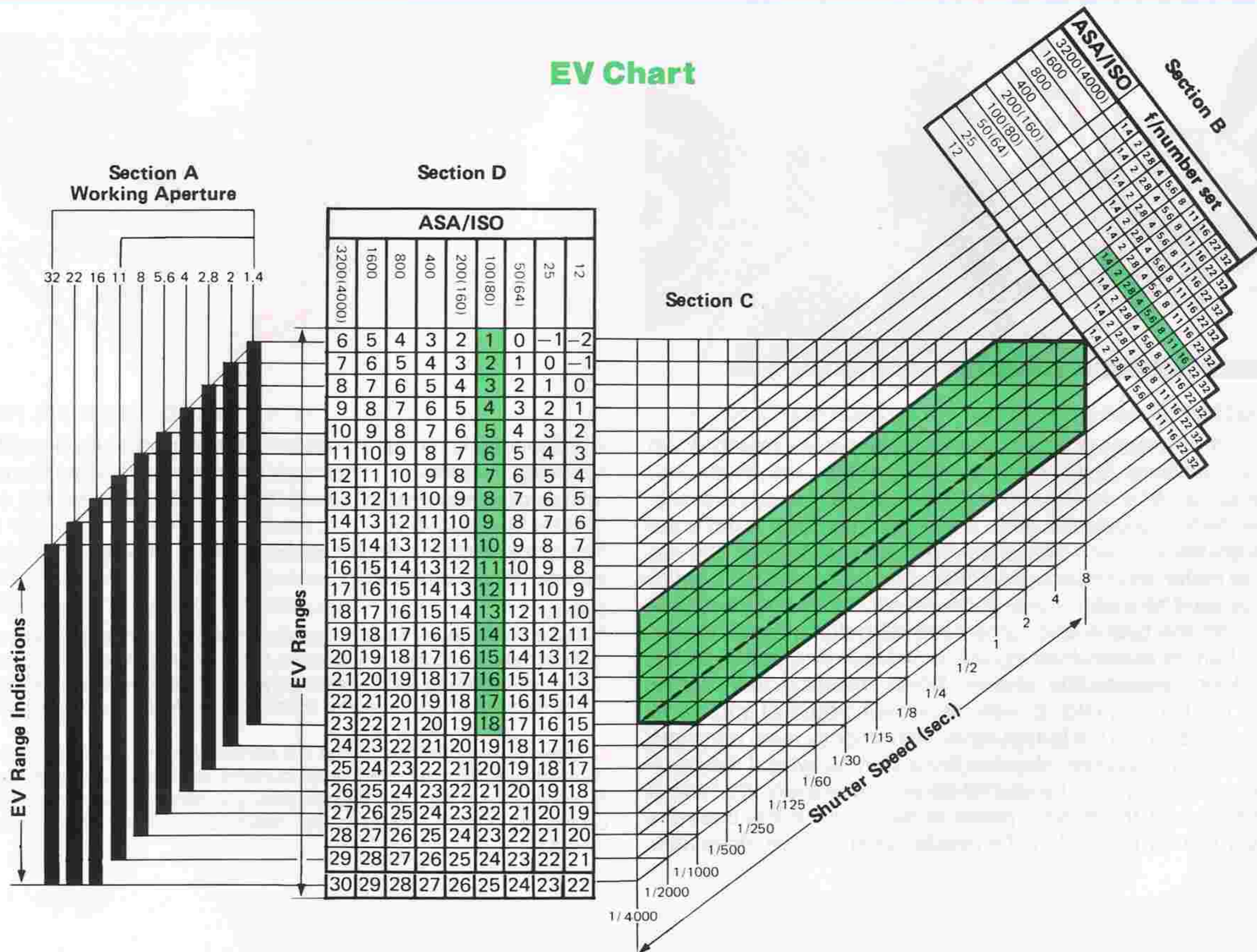

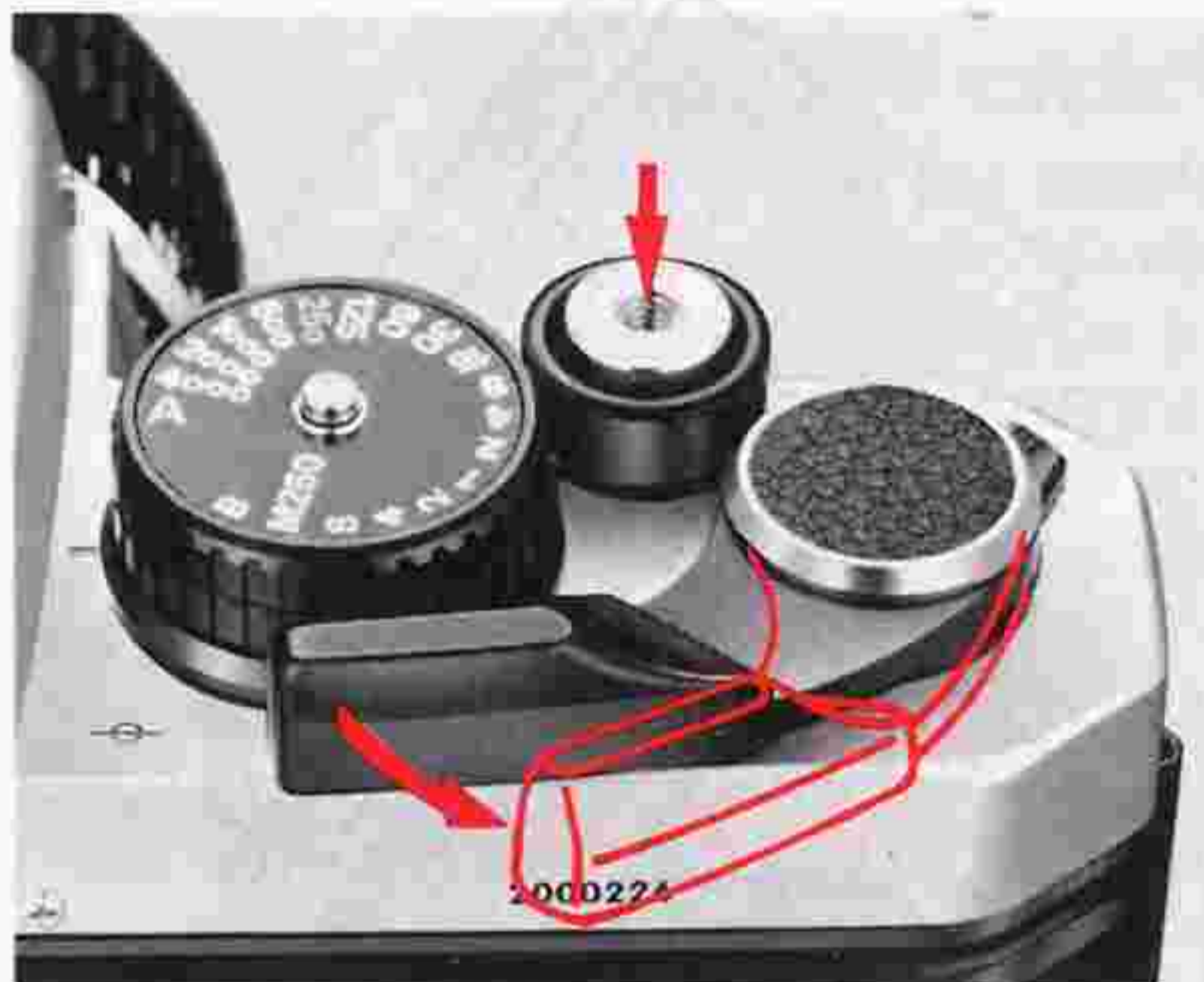

## Shutter Release Button ②

The shutter release button activates the exposure meter. When the film advance lever is in the flush position, the shutter release button is locked and does not operate. To release the lock, move the film advance lever to its standoff position. Slight pressure on the shutter release button then switches on the exposure meter and immediately the meter needle within the finder swings up. The meter stays on for 16 sec. after you take your finger off the button and turns itself off automatically to conserve battery power. Pushing the shutter release button all the way down releases the shutter. When releasing the shutter, touch the finger guard ③ with the inner surface of your forefinger and depress the button lightly with smooth, even pressure. To check battery power, depress the button halfway. If the black meter needle stays in the shutter speed range even after taking your finger off the button, power is sufficient. If the batteries are completely exhausted, the needle doesn't move, even after

you depress the shutter release button halfway. However, if the needle goes down the instant you remove your finger from the button, power is weak. In both of the above cases, you must change the batteries.

The shutter release button is threaded at the center to accept a standard cable release.

### Notes:

- 1) When the batteries are almost exhausted, the meter needle may drop the instant the shutter is released—this is not a malfunction.
- 2) The meter needle doesn't move until the frame counter reaches the first frame or when the shutter speed/mode selector is set at B or M250.

**Caution:** If you continue to use the camera until the batteries become completely exhausted, the shutter curtains will not open and the mirror ②⑥ will remain in the "up" position after you depress the shutter release button. To return the mirror to the "down" position, switch to the M250 setting.



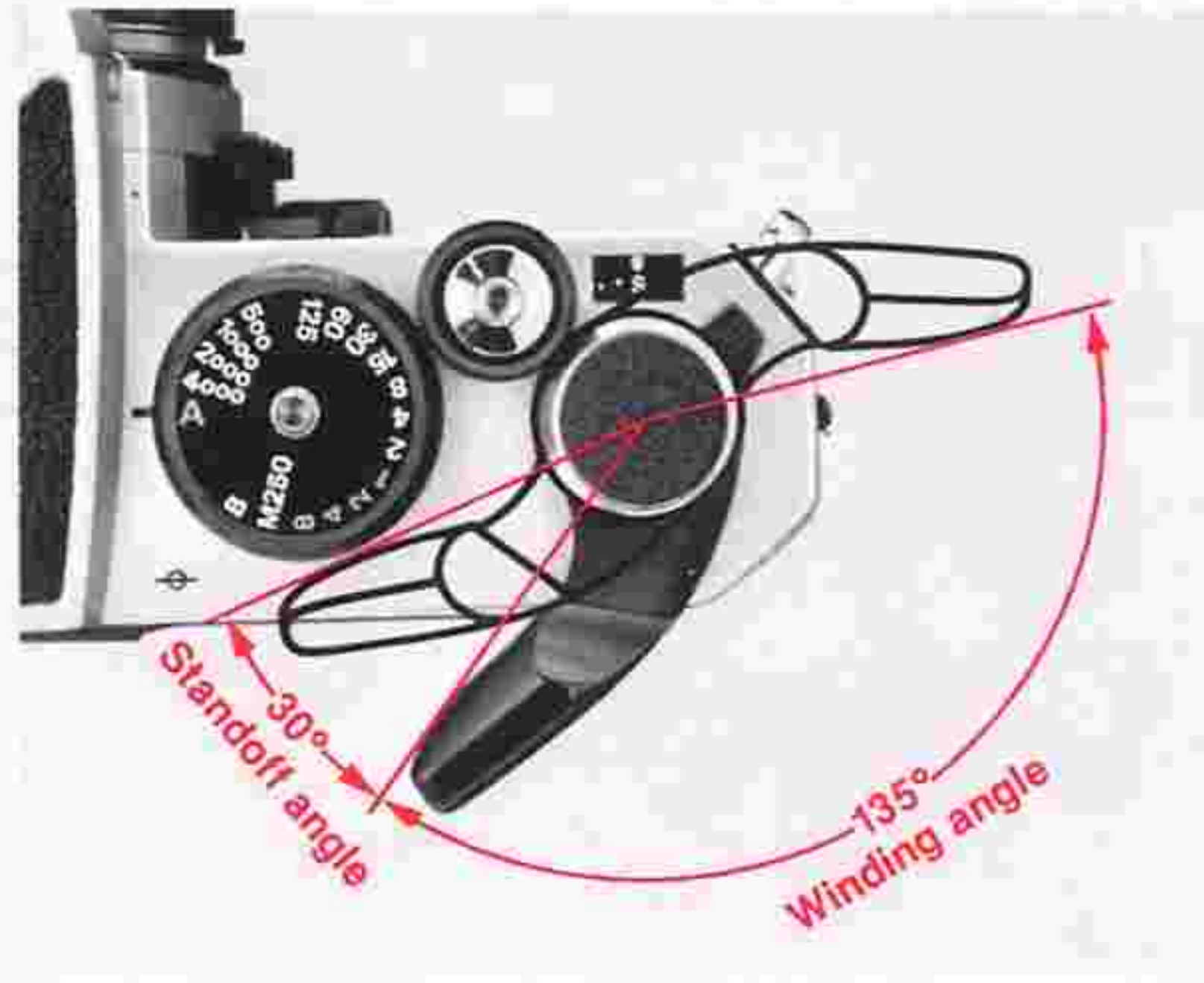

## Film Advance Lever 27

The film advance lever also functions to lock the shutter release button. The shutter release button lock is released when you move the lever to the standoff position. To advance the film, wind the lever to the right completely until it stops. The lever returns to the standoff position automatically after you take your thumb off the lever. A single complete stroke advances the film one frame and simultaneously cocks the shutter.

**Note:** At the end of the roll of film, the lever cannot be wound any further. In this case, don't force the lever; just release your finger, depress the film rewind button and rewind the film using the rewind crank.

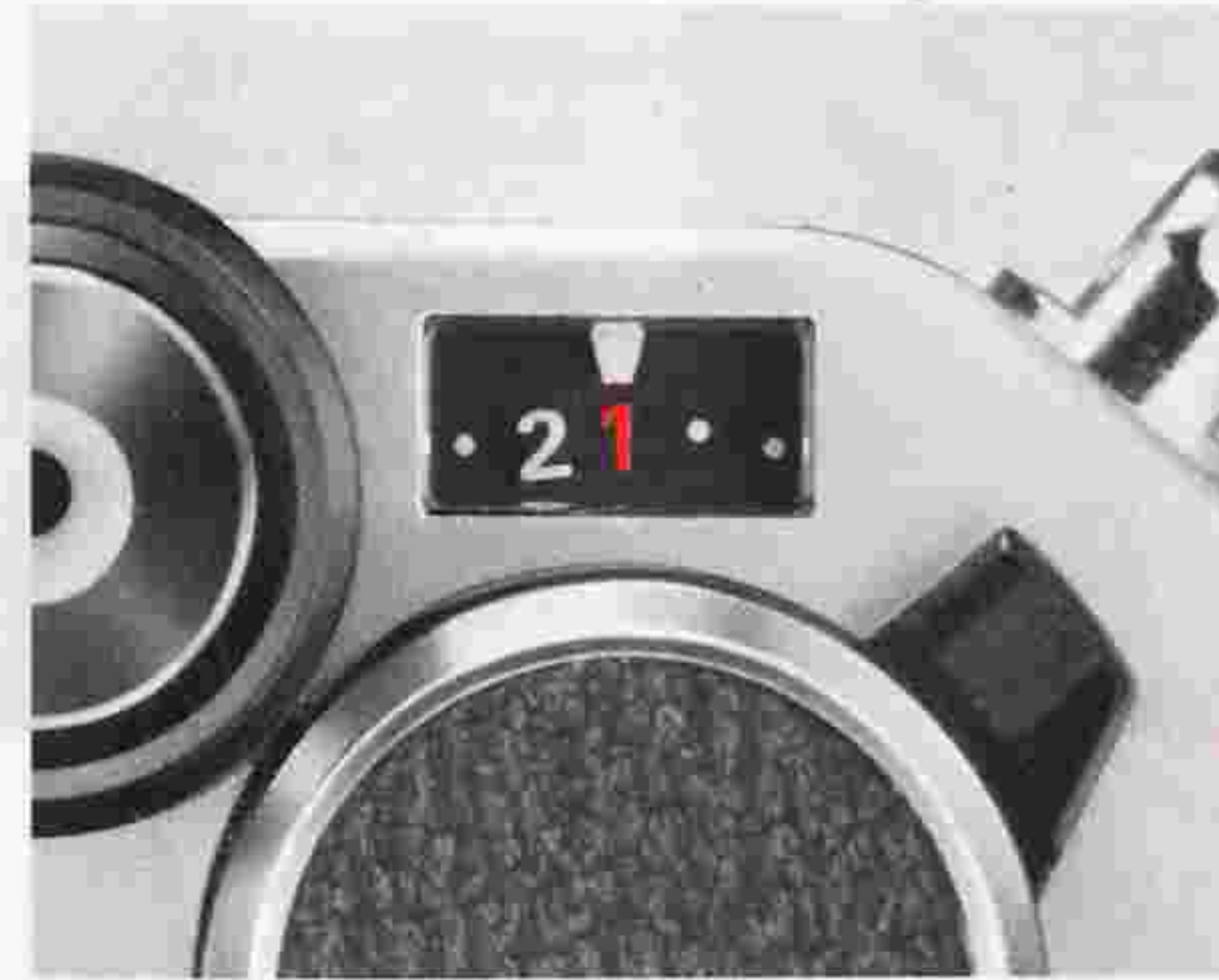

## Frame Counter 59

The additive type frame counter is graduated from S··1 2 4— up to 36 in even numbers with odd numbers indicated by white dots in between the even numbers. No matter whether the film cartridge is loaded properly or not, the frame counter still operates and advances a single frame by one complete stroke of the film advance lever. After reaching frame 36 of a 36-exposure roll of film, the counter will not operate even if you repeatedly press the shutter release button and wind the film advance lever; film will be advanced, however, until the actual end of the film roll. The frame counter automatically resets to S when the camera back is opened.

**Note:** Even on A, the automatic mode does not function prior to the first frame and, regardless of the lighting condition, the shutter speed is fixed at 1/250 sec. When the frame counter reaches one, the automatic exposure mode begins. On manual, the shutter speed is activated as set even prior to frame one.

# CONTROLS IN DETAIL—continued

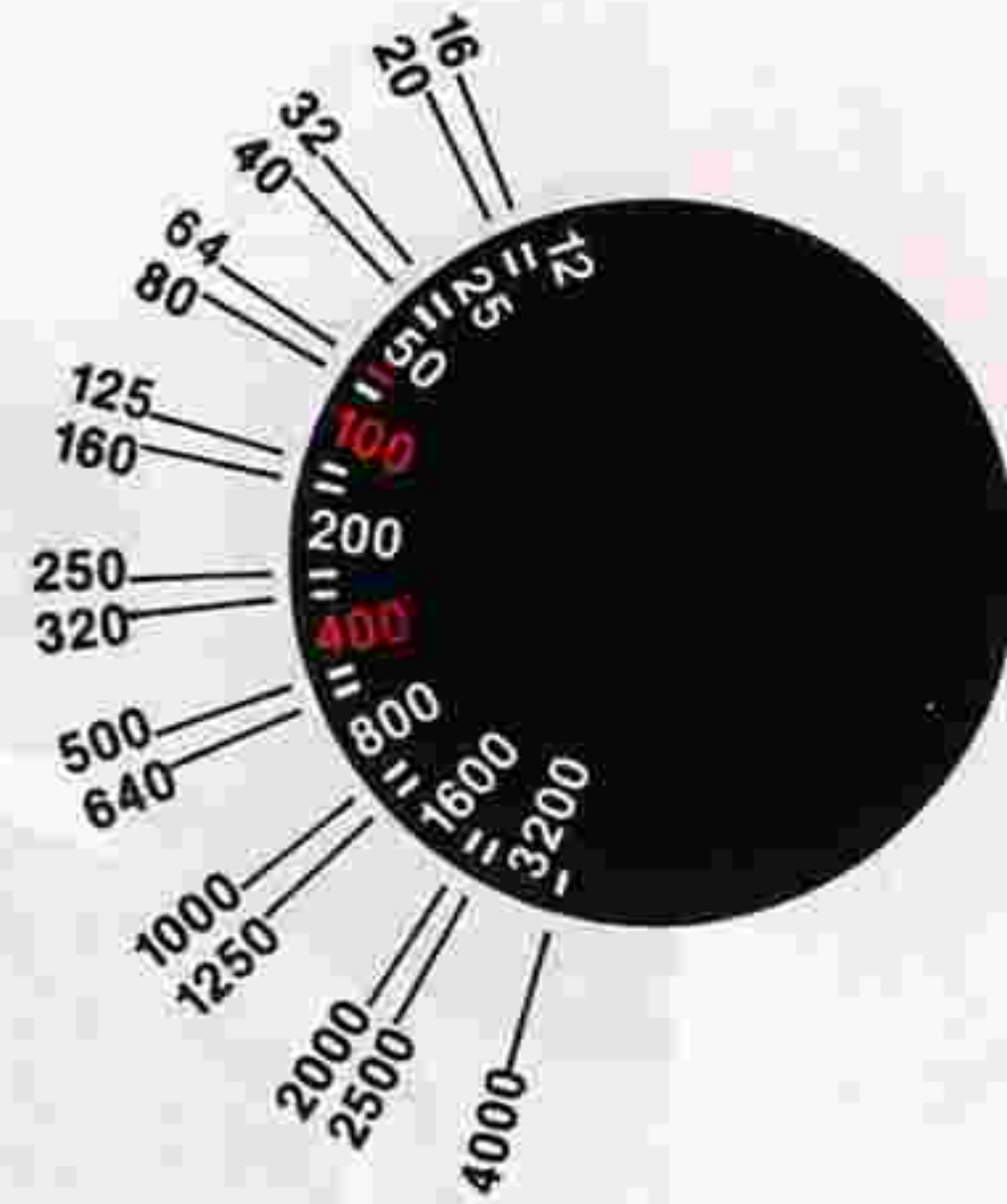
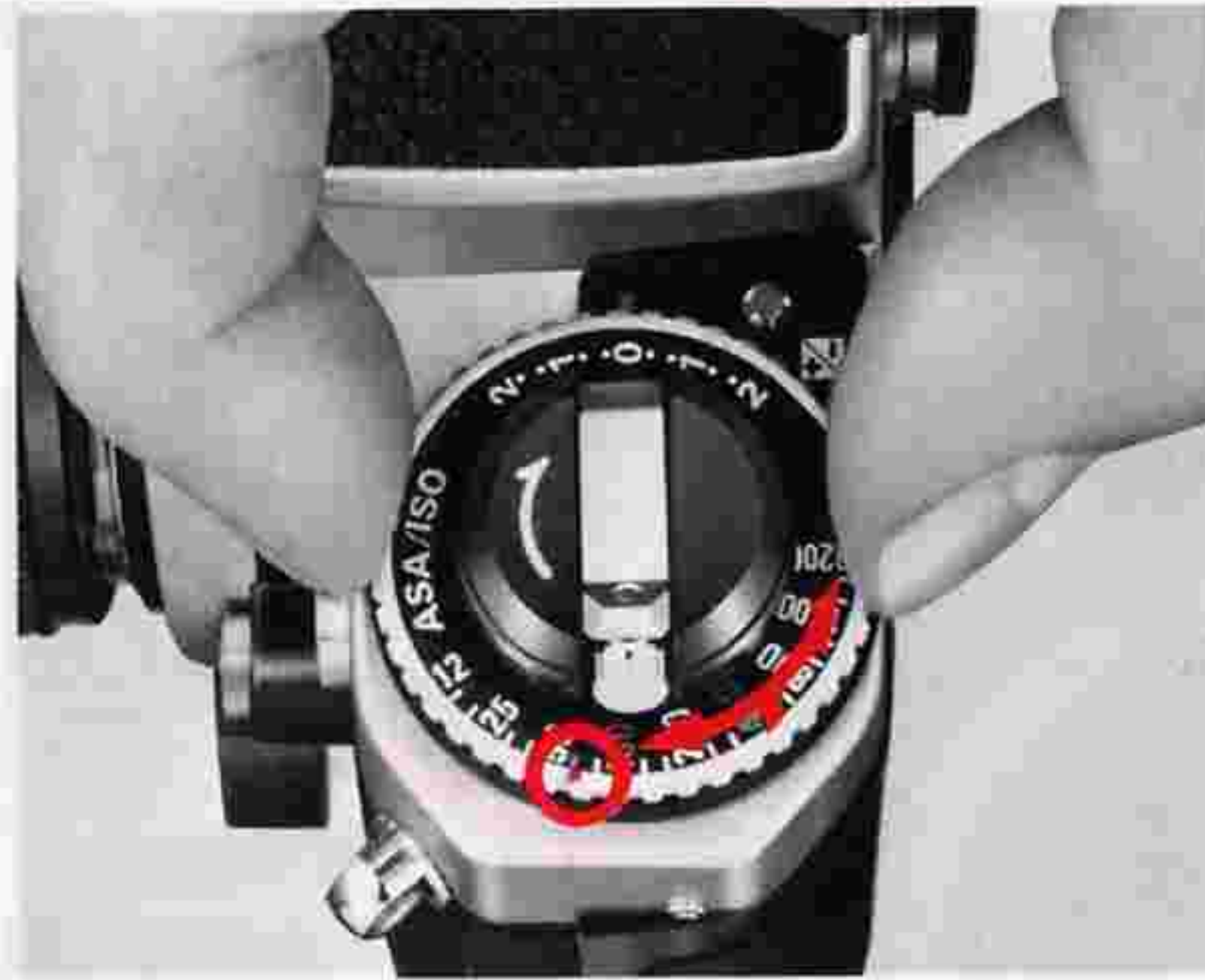

## ASA/ISO Film Speed Dial ⑪

The scale on the ASA/ISO dial has settings for speeds from ASA/ISO 12 to 4000. Two lines between each number stand for intermediate settings, such as 64, 80, etc. The diagram above gives the speeds for all intermediate settings. To set the film speed in use, lift up the dial and rotate it until your desired number (or line representing the film speed) click stops opposite the red index dot.

The ASA/ISO is a numerical rating of the film's sensitivity to a given amount of light. The higher the number, the greater the sensitivity, and vice versa. The film's ASA/ISO is indicated on the cartridge itself as well as on the film carton and the data sheet packed inside.

## Suggested Applications for Exposure Compensation



- +2 white background, snow scene
- +1 white background occupying half of viewing area
- 1 spotlighted subject, black background occupying half of viewing area
- 2 black background

## Exposure Compensation

When the overall scene is unusually light or dark in tone or there is a substantial difference in contrast between the main subject and the background, the camera's meter may be fooled into giving the incorrect exposure. In these cases, exposure compensation must be made. For your convenience, the FE2 features two controls for making exposure compensation—the exposure compensation dial and memory lock lever.

## Exposure Compensation Dial <sup>40</sup>

For unusual lighting situations, such as snowscapes, backlit subjects, or when the main subject contrasts sharply with the background, the exposure compensation dial allows adjustments to prevent over- or underexposure. Also, the dial can be used to obtain special effects like intentional over- or underexposure under normal lighting conditions. Conveniently operable on A, the dial ranges from +2EV to -2EV in one-third increments with the following exceptions:

- 1) At ASA/ISO 12  
Only 1 step compensation in the + direction is possible; the - direction is normal.
- 2) At ASA/ISO 16  
Only 1-1/3 steps compensation in the + direction is possible; the - direction is normal.
- 3) At ASA/ISO 3200  
Only 1-1/3 steps compensation in the - direction is possible; the + direction is normal.
- 4) At ASA/ISO 4000  
Only 1 step compensation in the - direction is possible; the + direction is normal.

## CONTROLS IN DETAIL—continued

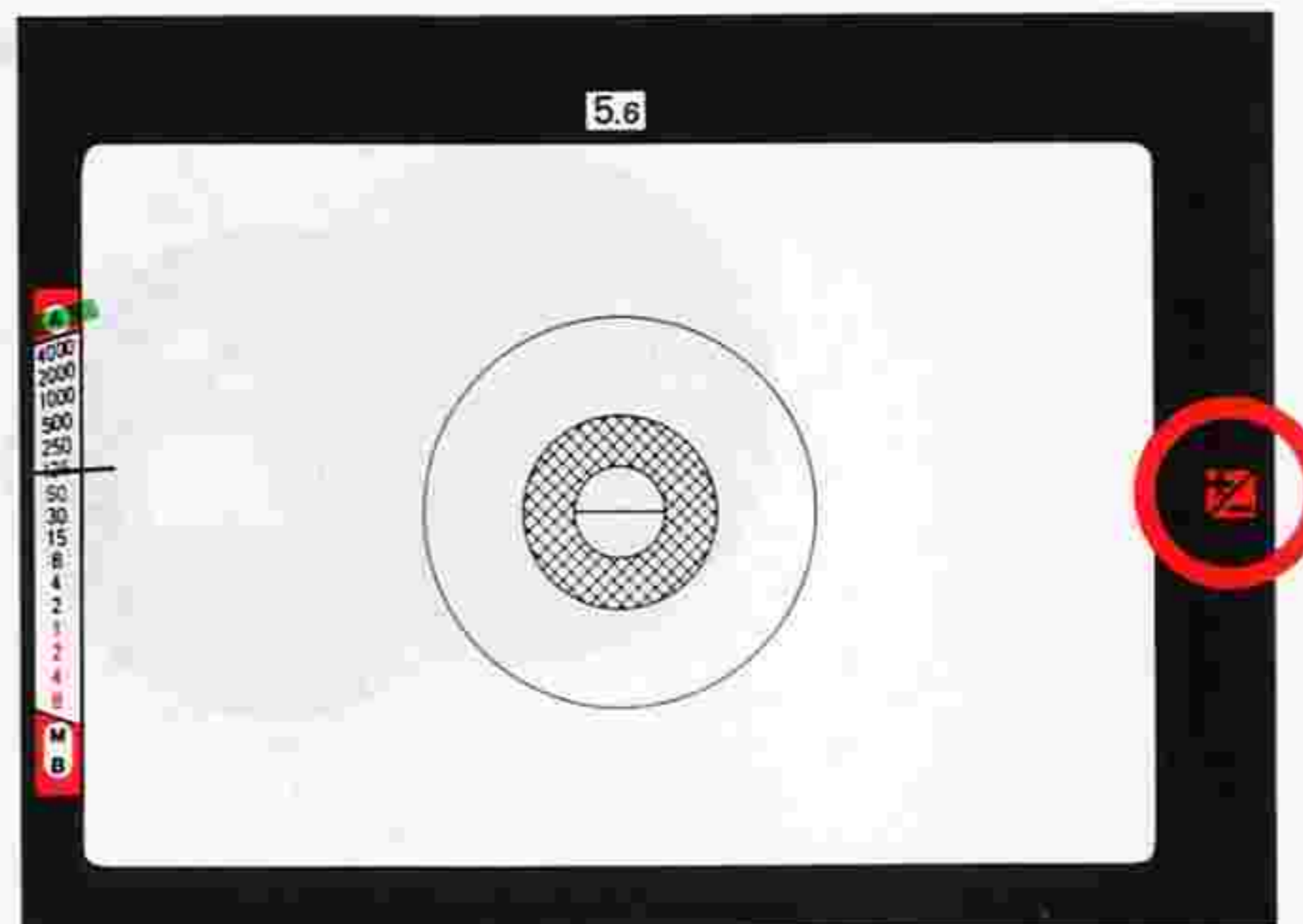
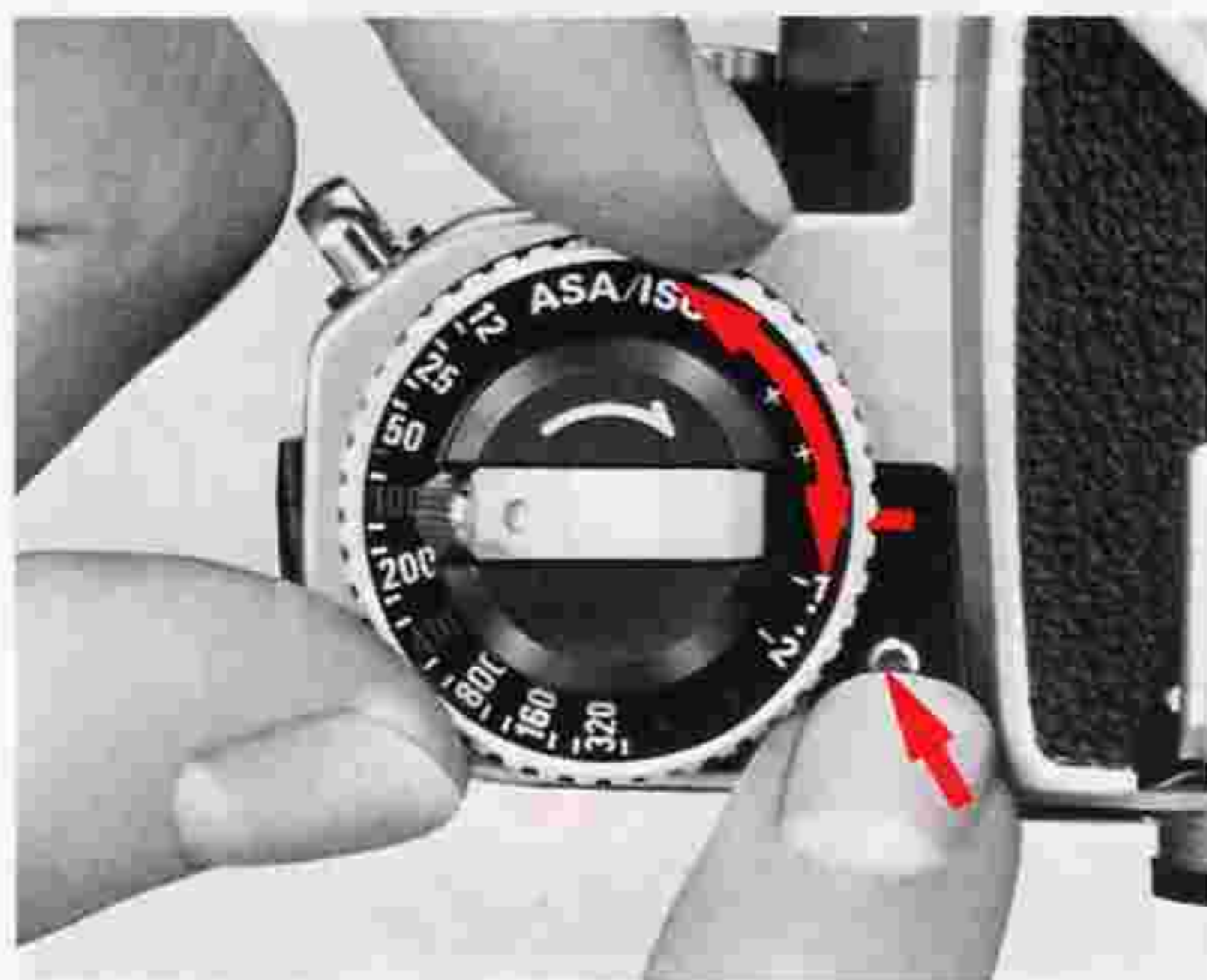

To operate, press the lock button and turn the dial until the desired compensation value click stops opposite the red index line. On A, the shutter speed is shifted, corresponding to the compensated amount. The red LED exposure compensation mark (+/-) also appears on the right side of the viewfinder after the shutter release button is depressed halfway (except when the shutter speed/mode selector dial is set at B or M250). After taking the picture, return the dial to 0; otherwise incorrect exposure will result in ordinary shooting.

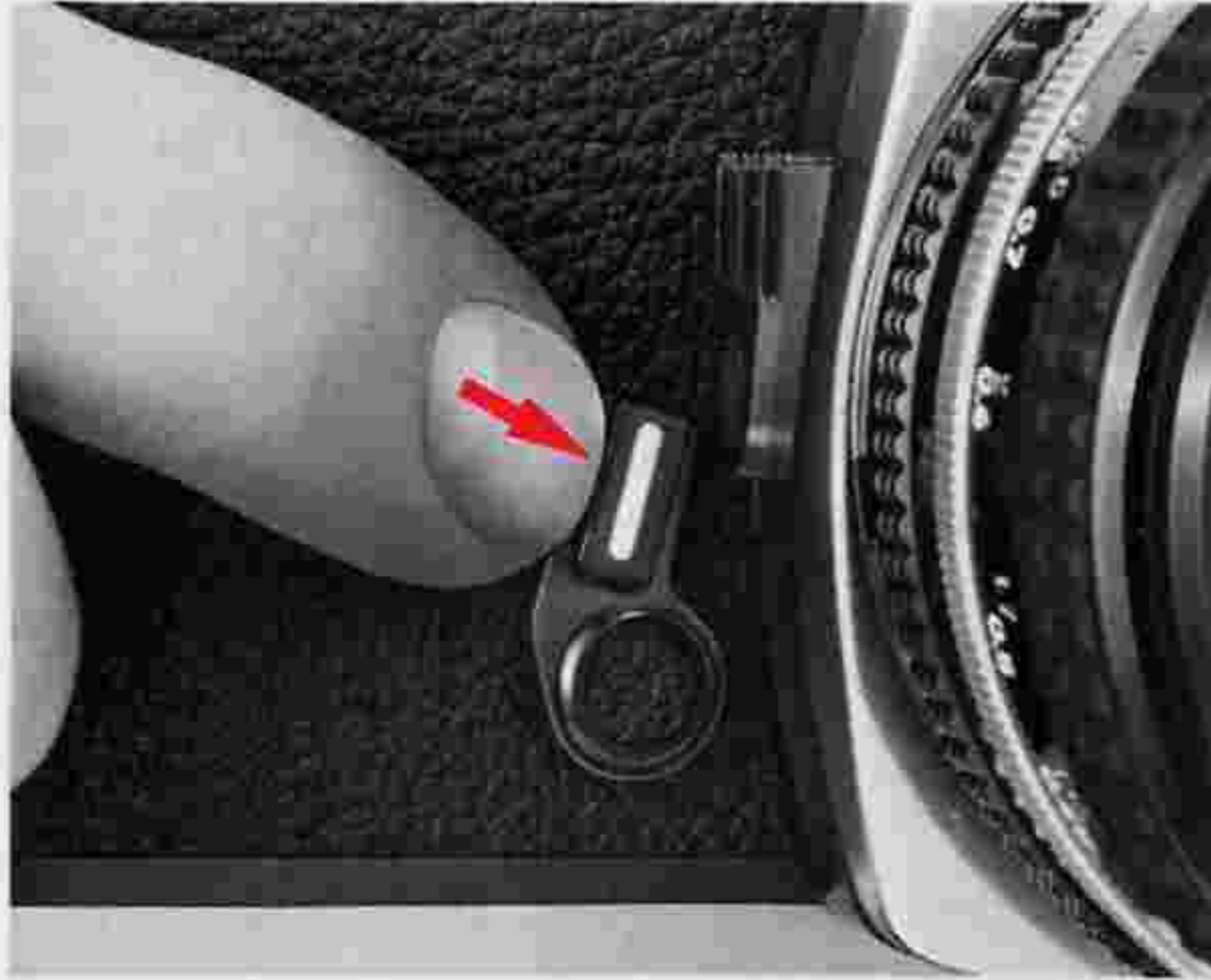

## Memory lock lever ⑥

Another way to make exposure compensation is to use the memory lock lever. When there is a substantial difference in brightness between the main subject and the background, such as a strongly backlit subject, the camera's exposure meter is likely to be fooled, resulting in under- or overexposure (Fig. 1). To compensate for this, center the main subject in the viewfinder or move in close to the subject, turn the memory lock lever towards the lens and hold it in; then recompose and shoot (Fig. 2).

The reading will be retained as long as the control is held in this position. The shutter speed is "locked in" electronically while you depress the lever. The meter needle is also locked and doesn't move.

### Notes:

- 1) Be sure to switch the meter on prior to using the memory lock. If the procedure is reversed, the correct exposure cannot be obtained.
- 2) During memory lock operation, the meter remains on, then automatically turns off 16 sec. after releasing your finger off the lever.



Fig. 1



Fig. 2

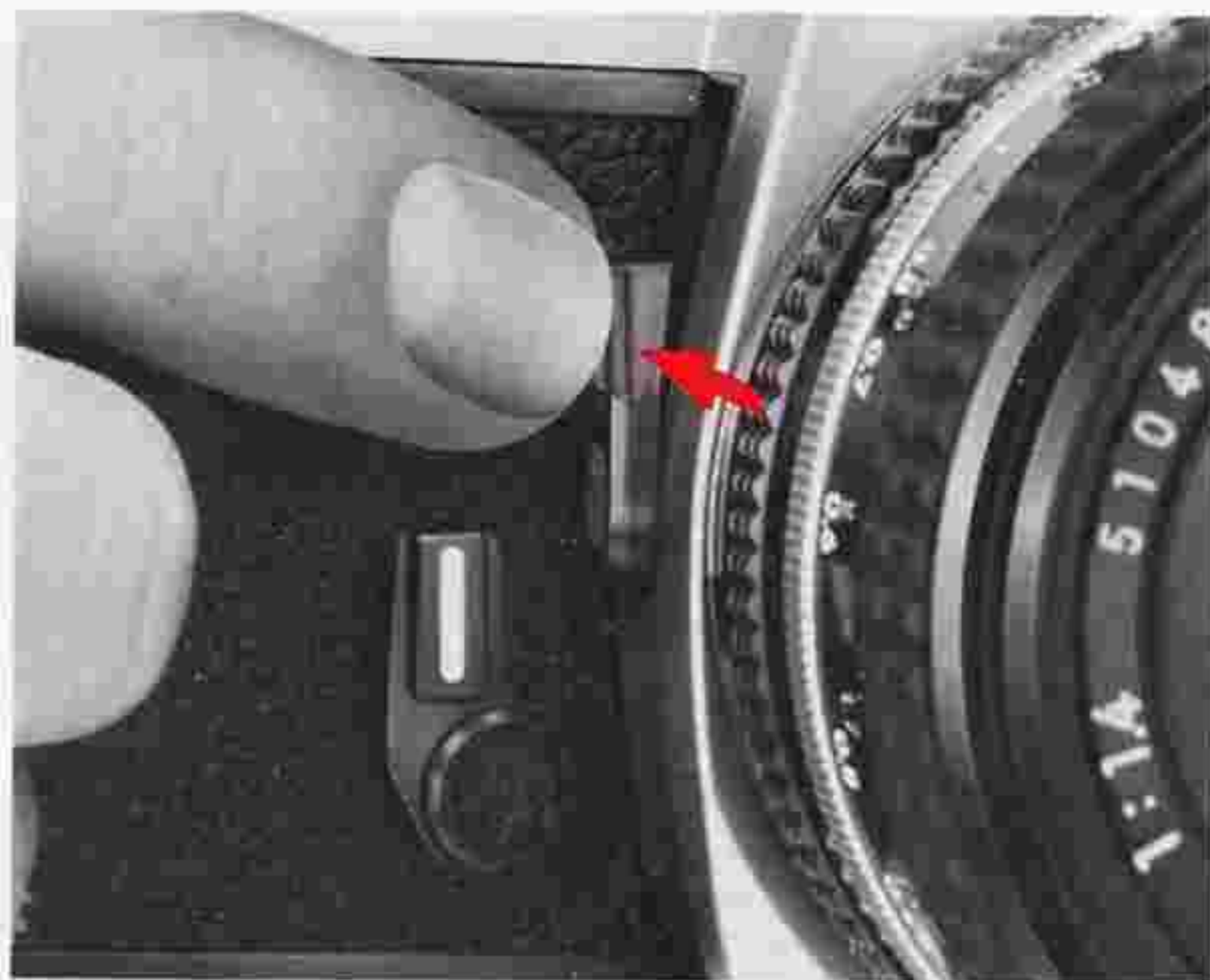

## Depth-of-Field Preview Lever ⑤

When a lens with an automatic diaphragm is used, the image in the viewfinder is viewed with the diaphragm of the lens wide open. However, pressing the depth-of-field preview lever will cause the lens to be stopped down to the f-number set, enabling you to examine depth of field before shooting. The image in the viewfinder “darkens” according to the selected f-number—the smaller the aperture, the darker the image. The areas of the picture that appear in focus when the lever is pressed will be within the zone of sharp focus in the final photograph.

**Note:** Be sure to depress the depth-of-field preview lever fully. Also, release the lever before you depress the shutter release button.

## Depth of field

Depth of field refers to the zone of sharp focus in front of and behind the main subject in the final photograph. Because the FE2 features aperture-priority automatic exposure, you have complete control over depth of field by varying the f/stop. The following are important points to remember:

- 1) By stopping down the diaphragm to smaller apertures (indicated by numerically larger f-numbers on the aperture ring), depth of field becomes deeper and not only your main subject but the foreground and background will also be in sharp focus. On the other hand, by using wider apertures (smaller f-numbers), depth of field becomes shallower and both foreground and background will be out of focus, thus enabling you to emphasize the main subject.
- 2) The farther the subject is from the camera, the deeper the depth of field; the closer to the camera, the shallower the depth of field.
- 3) Usually, background clarity is sharper than that of the foreground; thus, in shallow depth-of-field situations, you can expect your foreground images to be less clear than those behind the subject.
- 4) The shorter the focal length of the lens, the deeper the depth of field at each f/stop.
- 5) With most Nikkor or Nikon Series E lenses, depth of field is indicated by pairs of colored lines on the lens ③③ which correspond to the colors of the f-numbers engraved on the aperture ring. Therefore, the depth-of-field range can be determined by reading off the corresponding distances using the depth-of-field scale (see example photos).



Lens set at  $f/1.4$   
Only main subject is in focus.



Lens set at  $f/16$   
Most objects near to far are in focus.

# CONTROLS IN DETAIL—continued

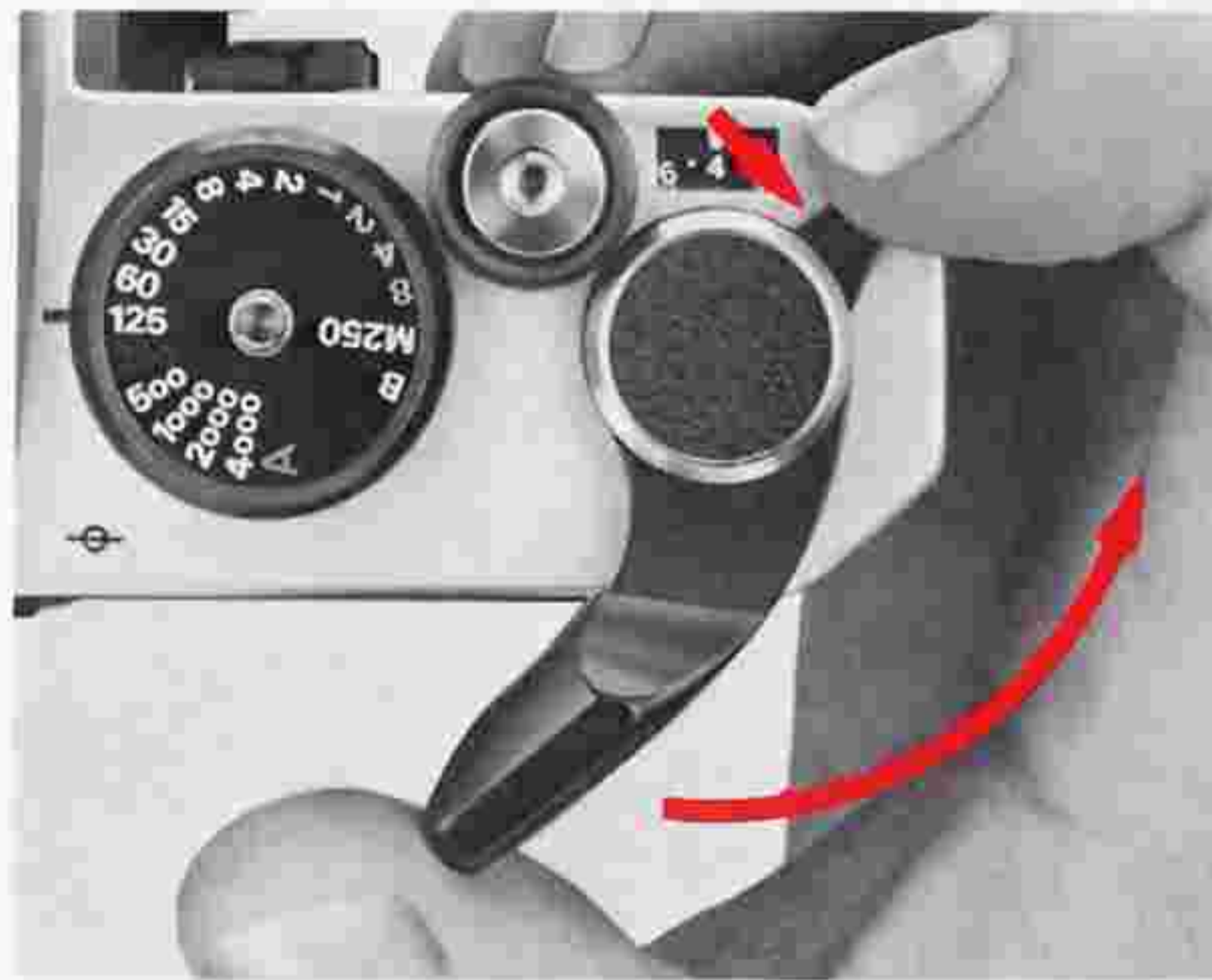

## Multiple Exposure Lever 58

A multiple exposure is defined as a picture of different subjects or two or more shots of the same subject on the same frame of film. To make a multiple exposure, follow these steps:

- 1) Take the first shot.
- 2) Pull the multiple exposure lever in the direction of the arrow shown in the photo, as you wind the film advance lever fully. The frame counter will not advance; only the shutter is ready to be released again.
- 3) After winding the film advance lever fully, take the second shot. To take three or more shots on the same frame, repeat the procedures described in 2) and 3).

### Notes:

- 1) The multiple exposure lever must be pulled back at the start of film winding, but need not be pulled back after that.
- 2) In multiple exposure photography, the FE2 is designed to reduce film dislocation to the minimum. But it may occur due to film curling, film slack or inappropriate film winding.





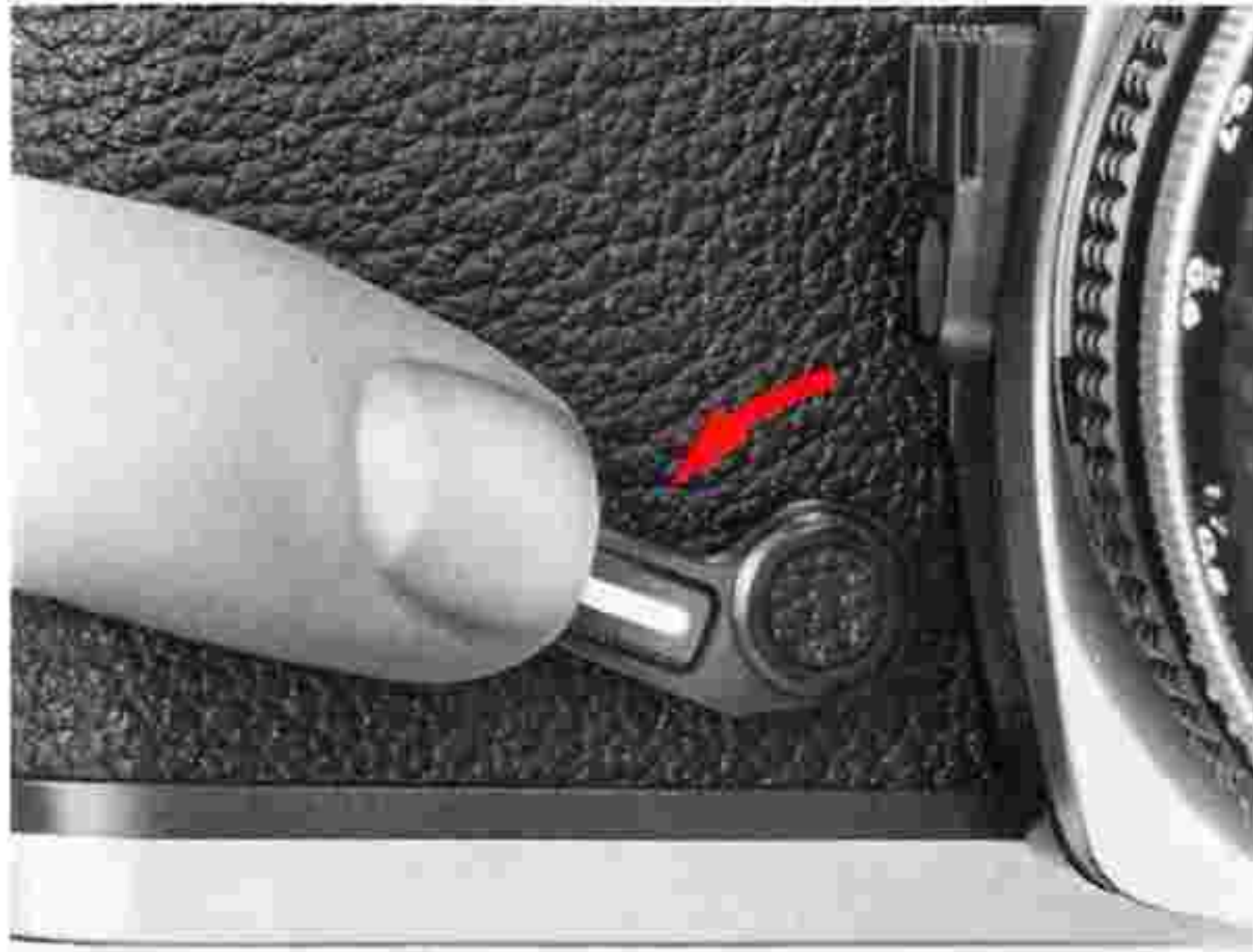

### Self-Timer Lever ⑥

This device is useful in taking self-portraits or when you want to include yourself with other people. Set the self-timer by turning the lever as far as it will go in the direction of the arrow shown in the photo. This can be done either before or after the film is advanced. After the self-timer has been set, press the shutter release button. The reflex mirror will go up and the self-timer will start to operate; the shutter is released after a delay of approx. 10 sec. If you want to cancel self-timer operation after the lever has been set, move it back to its original position with your finger. You can then take the picture the ordinary way, as before. However, turning the self-timer lever when it is already in operation will result in the shutter being released the moment the lever is back in its original position. With the exception of B, the self-timer can be used at any shutter speed.



### Memo Holder ⑤⑩

To remind yourself of the film type and the number of exposures on the roll of film in use, clip off the end of the film package and insert it into the memo holder. Of course, you can use the memo holder to store anything, such as your name card.



## Infrared Focusing Index (35)

When you shoot infrared film, note that the plane of sharpest focus is slightly farther away than that in visible-light photography. As a rule of thumb, you can compensate for this shift in focus by referring to the infrared compensation index (in the form of either a dot or a line) near the focusing index on the lens barrel. (Some lenses, including the Reflex-Nikkor, do not need compensation.)

After focusing the image sharply through the viewfinder, check the focused distance and reset the focusing ring so that the red infrared compensation index lines up with the prefocused distance. Be sure to shoot with the appropriate filter, such as the R60, etc. (In this photo, subject-to-camera distance is set at  $\infty$ .)



## Film Plane Indicator (60)

The film plane indicator (☉) is engraved on the top deck just behind the shutter speed dial. It indicates the exact position of the film plane inside the camera and is used to measure the exact distance between the subject and film plane, such as in macrophotography. The distance between the film plane and lens mounting flange (7) is exactly 46.5mm.

# CLOSE-UP PHOTOGRAPHY

## Close-Up Photography

Nikon has a vast array of accessories for entering the exciting world of close-up photography:

- 1) Close-Up Lenses Nos. 0, 1, 2, 3T, 4T, 5T, and 6T.

Since these lenses are attached to the front of the lens in use, metering can still be done at full aperture.

- 2) Auto Extension Rings PK-11A, 12, and 13.

- 3) Bellows Focusing Attachment PB-6.

The Auto Extension Rings and the PB-6 are attached between the lens and camera body. If one of the rings is used with an AI lens, exposure determination is at full aperture because the exposure meter is linked to the automatic diaphragm of the lens. As for the PB-6, stop-down exposure measurement is necessary because the exposure meter is not linked with the automatic diaphragm of the lens. You can change magnifications continuously by extending the bellows.

Note, too, that it is possible to use a close-up lens, ring and the PB-6 all at the same time.

- 4) Micro-Nikkor 55mm f/2.8, AF Micro-Nikkor 55mm f/2.8, 105mm f/2.8, and 200mm f/4 IF. These specially designed lenses offer continuous focusing from infinity down to 1/2X lifesize. The closest focused distance of the lenses are 0.25m (0.82ft), 0.23m (0.75ft), 0.41m (1.34ft), and 0.71m (2.84ft), respectively.

Note that in close-up photography, depth of field is generally shallow. Thus, you should stop down as much as possible in photographing a subject with very little depth. It is also advisable to use the Type K2's matte field for focusing, because it is not easy to focus with the split-image range-finder or microprism collar. Or use Type B2 or E2 instead.

**Note:** Non-AI extension rings, such as the PK-1, 2, 3, PN-1, etc., cannot be attached to the FE2.



Micro-Nikkors

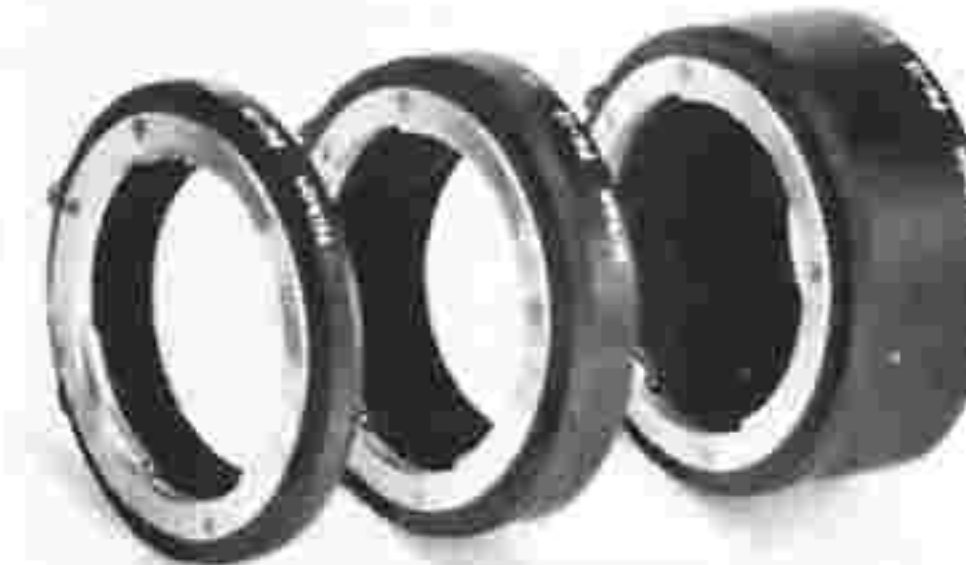

Auto Extension Rings



Close-Up Lenses

Bellows Focusing Attachment

# CLOSE-UP PHOTOGRAPHY—continued

## Duplication Work and Photomicrography

In copy work, slide duplication, and photomicrography, you cannot obtain correct exposure by simply referring to the FE2's exposure meter display because these types of photography represent unusual contrast situations. Exposure compensation is required. Shown here is the table of the relationship between specific photo types and proper exposure. Since this is meant to be a guide, in practice you should make further compensation by experimentation until you achieve the proper results.

- The exposure compensation values listed below are reference data obtained when general-purpose film was used. With color reversal film or microfilm for duplication work, it is advisable to take additional shots with  $\pm$  one-stop exposure compensation as these films have very small exposure latitude.
- To avoid vibration, you can make the exposure by turning the illumination on and off.
- It is advisable to use a cable release to avoid camera vibration.

	Subject	Method of exposure measurement	Exposure compensation	Required accessories	Remarks
Copy work	Photographs and pictures with continuous gradation	Full-aperture or stop-down	Compensation not necessary	Micro-Nikkor 55 mm f/2.8 Cable release	For high-contrast subjects, use of an 18% reflectance gray card in determining exposure is recommended. With the card, no exposure compensation is required regardless of whether the background is black or white.
	Documents and drawings of high contrast		Approx. +1 to +2 stops for black letters on white background; approx. -1/2 to -1 stop for white letters on black background.		
Slide duplication	General film with continuous gradation	Stop-down	Approx. +1 to +2 stops	Micro-Nikkor 55 mm f/2.8 Nikon Slide Copying Adapter PS-6 Nikon Bellows Focusing Attachment PB-6 Cable release	When using Nikon Slide Copying Adapter PS-6, set the flood lamp 30cm away from its opal plate.
	Film of documents and drawings photographed		Approx. +1-1/2 to +2-1/2 stops for black letters on white background		
			0 to approx. -1/2 stop for white letters on black background		
Photomicrography	Prepared specimen	Stop-down	Approx. +1 stop	Microflex PFX	Generally, results come out better with more exposure in photomicrography. The compensation value on the left is only a guide; determine the compensation value by test shooting.

*+: more exposure; -: less exposure.*

# FLASH PHOTOGRAPHY

An electronic flash unit is convenient not only for night and dim-light shooting but also as a supplementary light to fill in the shadows in daylight. With a Nikon dedicated flash, such as the SB-15, SB-16B, SB-18 or SB-20, the FE2 offers fully automatic through-the-lens (TTL) control of the flash exposure. This means that while the shutter is open, the camera's silicon photodiode (SPD), located at the bottom of the mirror box, reads the light reflected directly off the film and tells the flash unit to cut itself off when the exposure is correct.

**Note:** Usable film speed range for TTL flash photography is ASA/ISO 25 to 400.

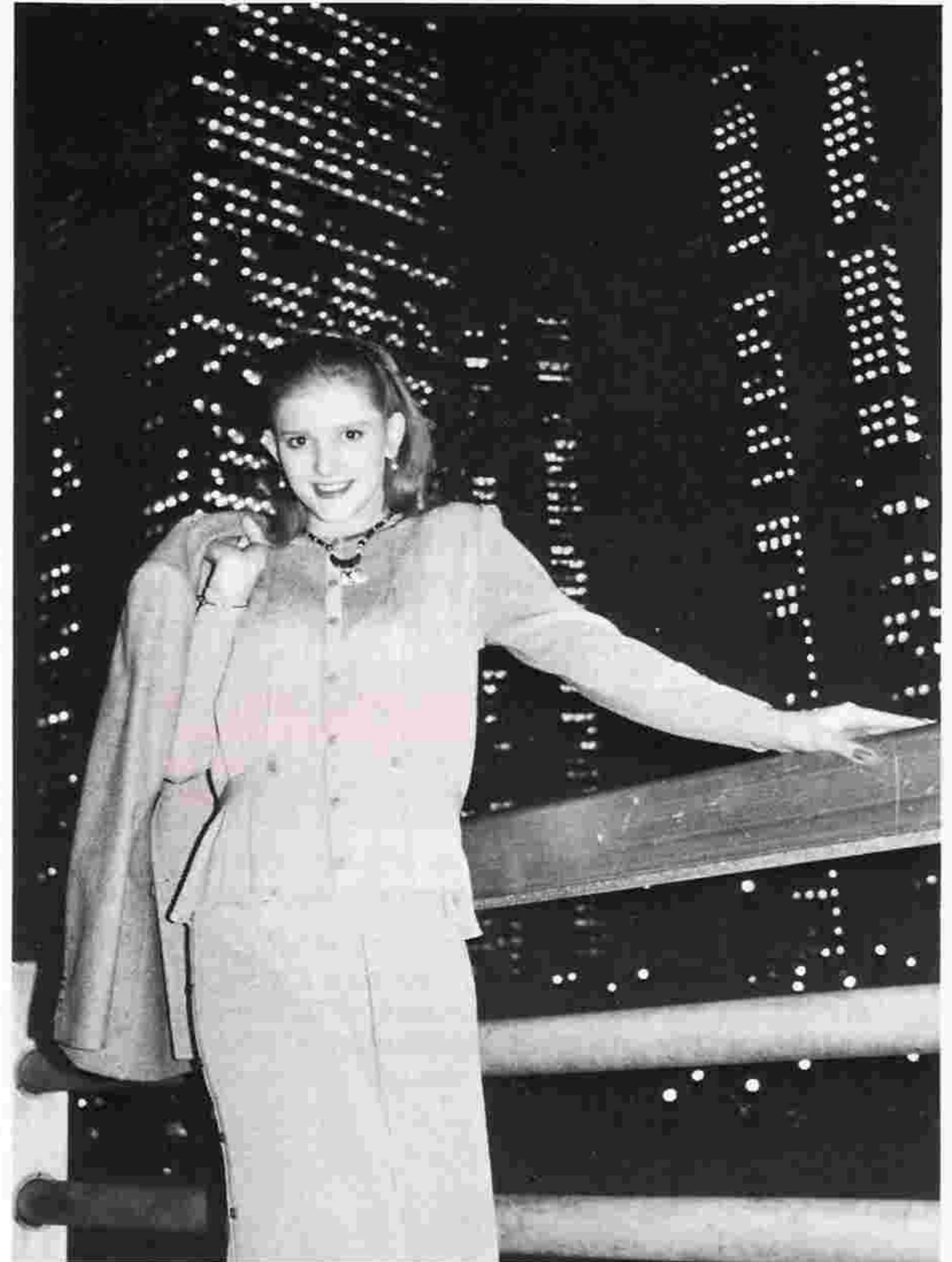

# FLASH PHOTOGRAPHY—continued

The FE2, provided only with an X-contact for synchronization, synchronizes with the speedlight when the shutter speed set is 1/250sec. or slower. To prevent mistakes, the camera also offers automatic switchover of the shutter speed for proper synchronization with a Nikon dedicated flash unit, such as the SB-15, SB-16B, SB-18 or SB-20. With the shutter speed/mode selector dial set at A or 1/500sec. or above, the shutter speed is automatically switched to 1/250sec. as soon as the flash is turned on. For creative fill-in flash effects, you can set the speed manually to 1/250sec. or below and the shutter fires at the speed set with the speed in use indicated in the viewfinder. Daylight fill-in flash is especially effective when shooting outdoor subjects which are backlit or in motion (see the example photos at right). With flash units other than Nikon dedicated ones, set the shutter speed manually to 1/250sec. or below. Flashbulbs can also be used at the following shutter speed sync ranges.

Shutter speed (sec.)	1/4000	1/2000	1/1000	1/500	1/250	1/125	1/60	1/30~8	M250	B
Speedlight										
M, FP and MF Flashbulbs										

- Synchronized
- Cannot be used

**Note:** When using a special electronic flash unit with provision for time lag, an electronic flash unit with long flash duration, the Medical-Nikkor 120mm f/4 IF, or the Nikon Repeating Flash Unit SB-6 at 1/2 or full output, adjust shutter speed down to 1/125sec. or slower.



In daylight fill-in flash, a sync speed of 1/60 sec. does not freeze the movement of the model airplane.



But, at 1/250 sec., all movement is stopped.



### Accessory Shoe ⑥①

Located at the top of the pentaprism viewfinder, the hot shoe allows direct mounting of the Nikon Speedlight SB-15, SB-16B, SB-18, SB-20 or any electronic flash with an ISO-type mounting foot. Other flash units may be mounted with a flash unit coupler (see the table on page 49). Four electrical contacts provide proper synchronization of the flash unit ③⑨, automatic flash output stop ⑥②, identification of a TTL flash unit ③⑧, and both ready-light indication in the camera's viewfinder (via an LED) and auto switching to the proper sync speed of 1/250 sec. ⑥③ with Nikon dedicated flash units.

**Caution:** The use of other manufacturers' flash units, even with the same ISO-type mounting foot, may cause abnormalities to the IC circuitry. Units having a high voltage sync circuit may also cause damage in shutter speed precision.

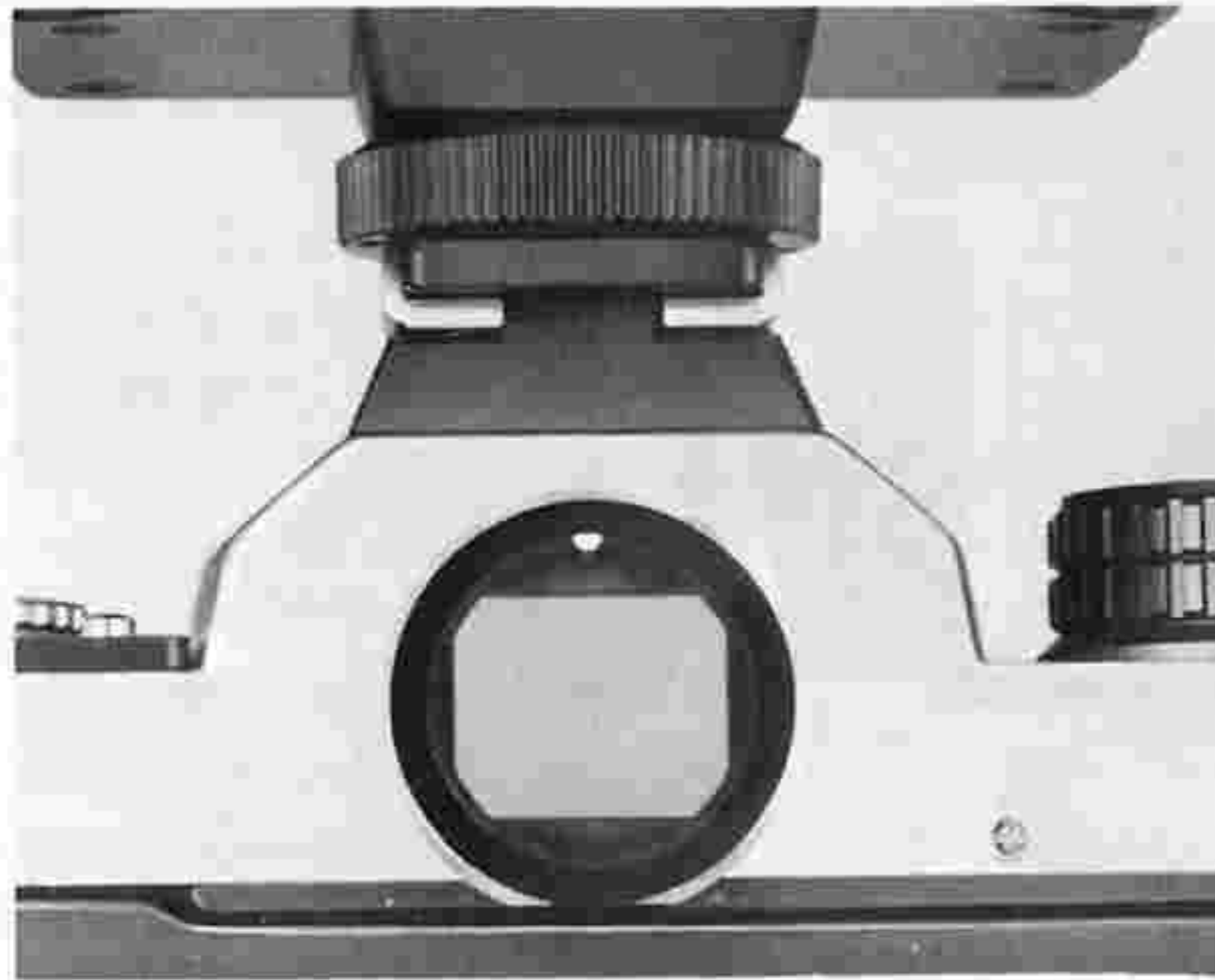

## Viewfinder Ready-Light ⑨

When the Nikon FE2 is used together with Nikon Speedlights such as the SB-15, SB-16B, SB-18, SB-20, etc., a viewfinder ready-light LED lights up when the flash is recycled. This way, you're easily informed of flash readiness without having to take your eye away from the viewfinder. Depending on which Nikon flash unit is attached, the same LED blinks to warn of insufficient flash output, incorrect setting of the flash unit or incorrect setting of the FE2. For more detailed information, refer to the flash unit's instruction manual.

## Relationship between the camera's on/off switch, shutter speed, and ready-light

Shutter speed/ shooting mode selector dial	Camera's exposure meter			
	On		Off	
	Ready- light	Shutter speed	Ready- light	Shutter speed
A (auto)*	lights up	1/250 sec.	—	—
1/4000-1/500 sec.	lights up	1/250 sec.	—	—
1/250-8 sec.	lights up	as set	—	—
M250, B	—	as set	lights up	as set

*\*Because automatic exposure mode is cancelled as soon as the flash unit is turned on, you should determine the proper aperture beforehand.*



## Nikon FE2/flash unit combination chart

Flash unit	Connection	Camera's ready-light indication	Shutter speed automatically switched to 1/250 sec.	Usable flash modes
SB-21A	Via AS-6 coupler	Provided	Yes	Manual
SB-21B	Direct	Provided	Yes	TTL, manual
SB-20	Direct	Provided	Yes	TTL, auto, manual
SB-19	Direct	Provided	Yes	Auto
SB-18	Direct	Provided	Yes	TTL, manual
SB-17	Via AS-6 coupler	Provided	Yes	Auto, manual, MD
SB-16A	Via AS-6 coupler	Provided	Yes	Auto, manual, MD
SB-16B	Direct	Provided	Yes	TTL, auto, manual, MD
SB-15	Direct	Provided	Yes	TTL, auto, manual, MD
SB-11/14/140	Via SC-11 sync cord (provided)	Not provided	No	Auto**, manual
	Via SC-13 sensor remote cord	Provided	Yes	Auto**, manual
	Via SC-23 TTL remote cord	Provided	Yes	TTL**, manual
SB-12	Via AS-6 coupler	Provided	Yes	Manual
SB-10	Direct	Provided	Yes	Auto, manual
SB-7E	Via AS-2 coupler	Not provided	No	Auto, manual
SB-6	Via SC-6 sync cord	Not provided	No	Manual
	Via AS-2 coupler with SC-9 extension cord (with SU-1)	Not provided	No	Auto, manual
SB-E	Direct	Provided	Yes	Auto
Ringlight Unit SR-2	Via sync cord (provided)	Not provided	No	Manual
Macro Ringlight Unit SM-2	Via sync cord (provided)	Not provided	No	Manual
Medical-Nikkor 120mm f/4 IF	Via 2-pin sync cord SC-20 (provided)	Not provided	No	*
	Via 3-pin sync cord SC-22 (provided)	Provided	Yes	

\*Flash output is determined by the lens' ASA/ISO ring setting. The focusing ring is coupled to the diaphragm, so as the lens is focused, the aperture is simultaneously set to provide the correct exposure.

\*\*With SB-140, usable only for visible-light flash photography.

# ACCESSORIES

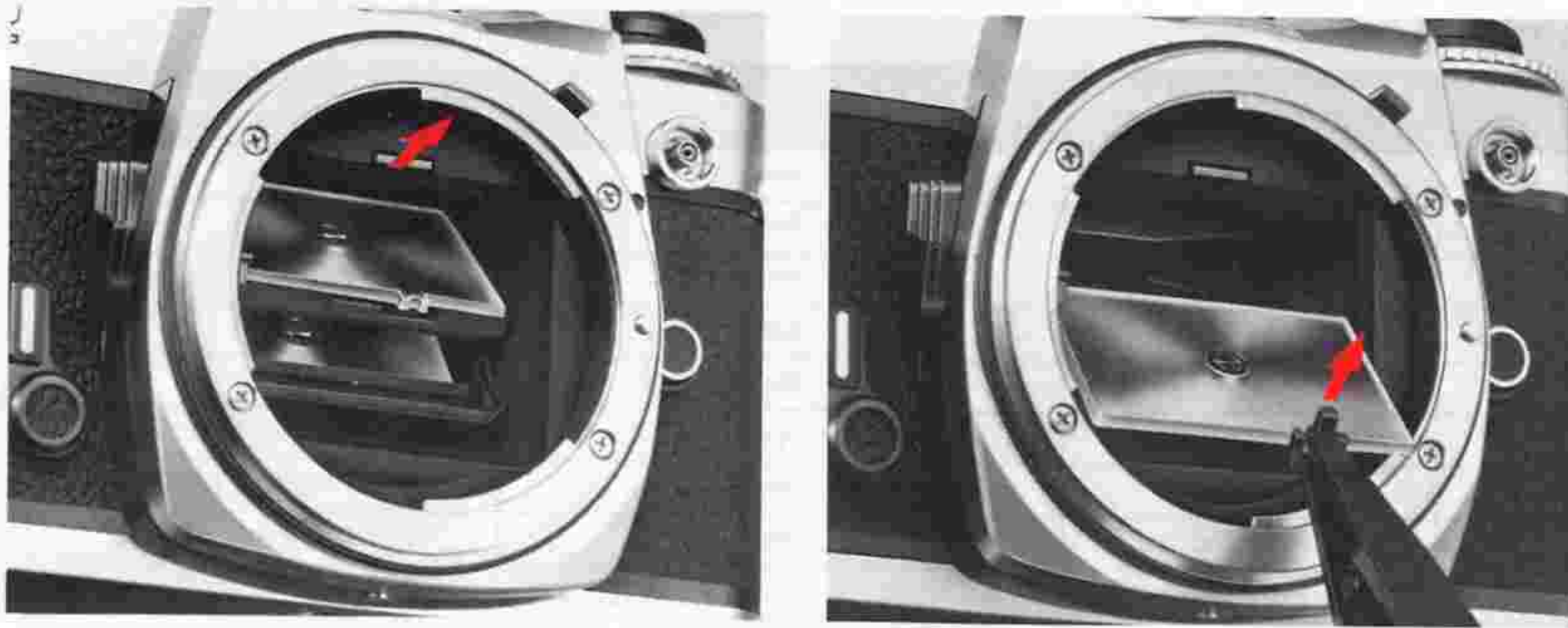

## Interchangeable Focusing Screens

Three different types of focusing screens are usable with the Nikon FE2. The Type K2 screen comes with the camera as a standard accessory. You can also use the optional focusing screens, Type B2 (matte/Fresnel with focusing spot) or Type E2 (matte/Fresnel with focusing spot and etched grid lines) to match your particular requirements.

### To change focusing screens, follow this procedure:

1. Remove the lens from the camera body.
2. Note the focusing screen release latch ⑧ at the top front of the mirror box casting. Slip the small tip of the special tweezers that come with the optional screens under the latch and pull outward to spring open the holder.
3. Take the screen out of the holder by grasping the small tab with the tweezers.
4. To mount another screen, carefully position it in place with the flat side face down and the side with the tab up.
5. Then push the front edge of the holder upward with the tweezers until it clicks into position.

#### Notes:

- 1) To avoid getting smudges or fingerprints on the screen's optical surface, do not handle the screen with your fingers.
- 2) TTL metering of the FE2 is adjusted in accordance with the clear-matte type finder screen. Therefore, when you change the focusing screen, please use those screens designated for the FE2.

## Focusing Screen Selector Guide

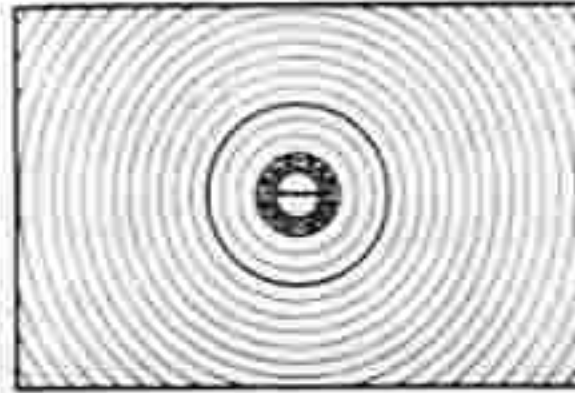
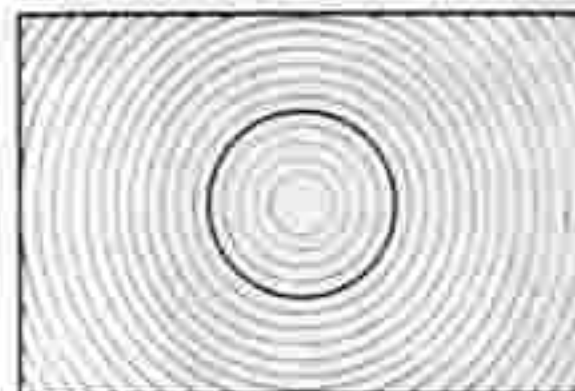
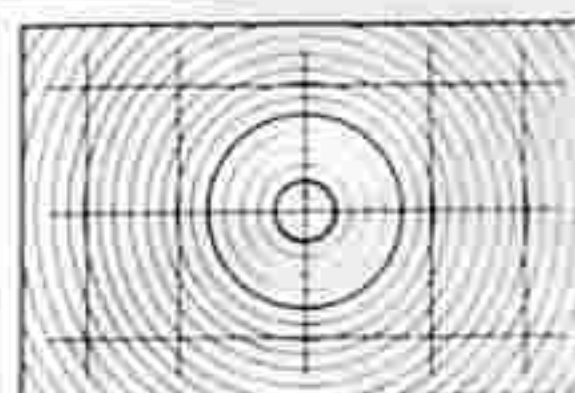
Type	Name/style	Features
 <p>K2</p>	Split-image rangefinder/microprism system	Suitable for general photography. Has microprism collar around the central split-image rangefinder spot. With PC-Nikkor or lenses having a maximum aperture slower than f/4.5, the split-image rangefinder or microprism collar is dim. In this case, focus on the surrounding matte area.
 <p>B2</p>	Matte system	Works well for general photography, close-up photography and duplication work. Especially useful for people who prefer to focus on the matte focusing spot at the center of the screen, or when it is inconvenient to use the split-image rangefinder for focusing, as is the case with telephoto lenses.
 <p>E2</p>	Horizontal and vertical line etched system	Extremely useful in pictorial composition. Consists of Type B2 matte field with etched horizontal and vertical lines. Especially handy when using PC-Nikkor lenses.

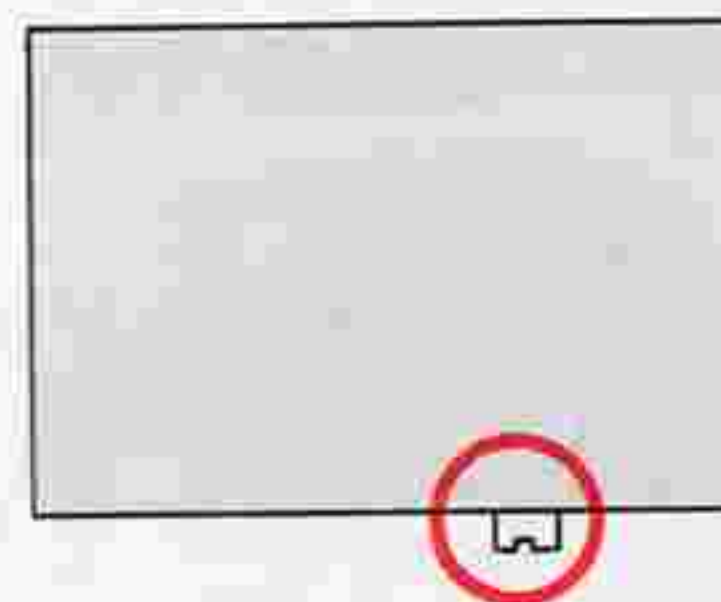

Type K2/B2/E2 screens

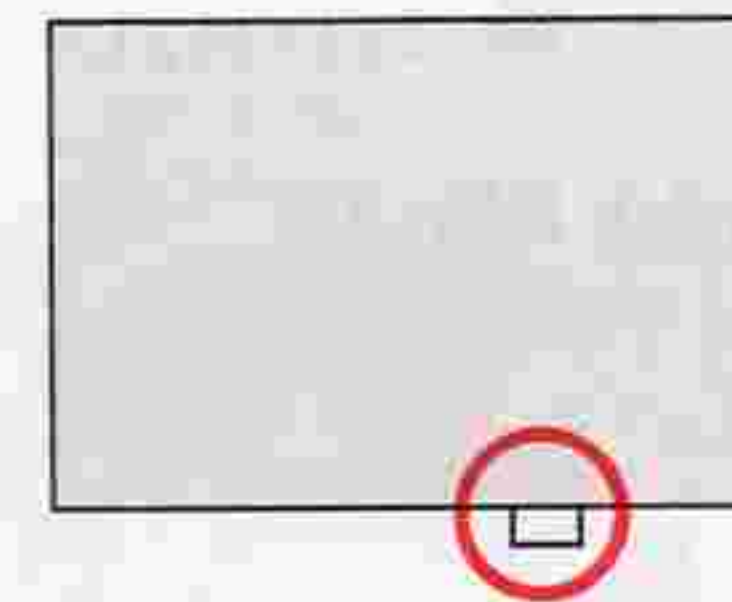

Type K/B/E screens

**Caution:** Type K2/B2/E2 focusing screens have a notched tab. If you use the Type K/B/E screen, you must make exposure compensation by setting the exposure compensation dial to  $-1/3$ . However, no exposure compensation is necessary when performing TTL auto flash photography with a Type K/B/E screen installed in the FE2.

# ACCESSORIES—continued

## Electronic Flash Units

Nikon offers four electronic flash units which mount directly on the camera's accessory shoe and feature TTL auto flash exposure control.

### Speedlight SB-15

The SB-15's flash head rotates a full 180° and its flash module tilts for bounce flash or close-up shooting. Guide number is 25 (ASA/ISO 100 and meters) or 41 (ASA/ISO 25 and feet).

### Speedlight SB-16B

The SB-16B has two flash heads for creative bounce flash; the main flash head tilts upwards 90° and rotates 270°; the smaller secondary head faces straight ahead to provide a catchlight for the eyes. Four-step zooming available. Guide number is 32 (ASA/ISO 100 and meters) or 52 (ASA/ISO 25 and feet) with the zoom set at N for lenses 35mm or longer.

### Speedlight SB-18

Lightweight and easy to operate. Guide number is 20 (ASA/ISO 100 and meters) or 33 (ASA/ISO 25 and feet).

### Speedlight SB-20

Cylindrical flash head rotates 90° upwards and 7° downwards. Three-step zooming provided. For manual flash operation, the amount of light output can be selected in five steps from full to 1/16. Guide number is 30 (ISO 100 and meters) or 49 (ISO 25 and feet) with the zoom set at N for lenses 35mm or longer.



SB-15



SB-18



SB-16B

## Motor Drive MD-12

The use of a motor drive unit with the FE2 enables automatic film advance when the unit's trigger button is pressed. In addition to single frame shooting, continuous firing at the maximum rate of 3.2 frames per second is possible (i.e., when the shutter speed set is between 1/125 and 1/4000 sec.). The motor drive unit proves very convenient when shooting fast-moving subjects since the photographer does not have to wind film manually or take his eye off the subject.

The MD-12 can be mounted onto the FE2 by simply inserting and tightening its built-in screw into the tripod socket  at the base of the camera body. Light pressure on the MD-12's trigger activates the FE2's exposure meter.



# ACCESSORIES—continued

## Data Back MF-16

To keep track of when photos were taken, the FE2 accepts the slim, lightweight Data Back MF-16 which attaches in place of the FE2's regular camera back with no sync cord required. Three imprinting modes are possible: year/month/day, day/hour/minute, or picture counting (up to 2000); each mode is displayed on the data back in clear LCD numerals and printed, if you choose so, on the photo in unobtrusive red LED numerals. Serving as a handy clock, a quartz timer with alarm function is incorporated.

**Note:** The Nikon FE2 also accepts Data Back MF-12. But in this case, a special cord is necessary to connect the socket contact of the MF-12 and the sync terminal 22 of the camera.



## Anti-Cold Battery Pack DB-2

In cold weather, use the Anti-Cold Battery Pack DB-2, which accepts two AA-type batteries, as an alternative power supply to the batteries inside the camera body. Simply connect the DB-2 to the camera body, then slip the assembly inside your pocket or coat to keep it warm. This assures that the camera's metering system will function even in very cold temperatures.

## Cable Release AR-3

The screw-type AR-3 makes for vibration-free shutter release.



# ACCESSORIES—continued

## Right-Angle Viewing Attachment DR-3

Screws onto the viewfinder eyepiece to provide a viewfinder image at a 90° angle to the camera's optical axis. Very helpful for closeup photography, duplication work, and photomicrography.

## Eyepiece Magnifier DG-2

Attached to the viewfinder eyepiece, this accessory enlarges the image at the center of the viewfinder to assure ever precise focusing in closeup photography, duplication work, and telephotography.

## Rubber Eyecup

Attached to the finder eyepiece, this eyecup excludes stray light and helps prevent eye fatigue.

## Eyepiece Correction Lenses

Accessory lenses that screw onto the viewfinder eyepiece ⑫ to enable near- and farsighted photographers to take pictures without having to wear eyeglasses. Nine models are available, offering a choice of the following diopters: -5, -4, -3, -2, 0, +0.5, +1, +2 and +3; the diopters represent the combined dioptery of the viewfinder and lens only. For best results, choose the eyepiece correction lens most suitable for you only after actually trying out various models at the camera shop.



DR-3



DG-2



Rubber Eyecup



Eyepiece Correction Lenses



## Filters

Made of optical glass produced in Nikon's own glassworks, Nikon filters allow you to balance the light to match your film or to create interesting artistic effects. As shown in the table, Nikon filters are broadly divided into the screw-in type and the drop-in type. For the Nikon FE2, the filter factor can be ignored except in the case of the R60. When using the R60 in tungsten lighting, set the aperture one f/stop wider than the figure indicated by the exposure meter.

### Notes:

- 1) For lens protection, the L37C is recommended.
- 2) When shooting a backlit subject or if there's a bright light source in the frame, a ghost image is likely to result from the use of a filter. In this case, you should take the picture without a filter.



## Lens Hoods

Recommended to prevent extraneous light from striking the lens, Nikon's lens hoods come in four styles: screw-in, slip-on, snap-on, and collapsible-rubber. Every lens should be fitted with the lens hood specially designed for it. Note, however, that some lens hoods can be used in common by several lenses.



Type	Filter designation	Filter factor		Screw-in type (mm)						Drop-in type (Series IX)	Bayonet-mount type			
		Daylight	Tungsten light	39	52	62	72	95	122			160		
For Both Color and Black-and-White Film	Skylight	L18C	1	●	●	●	●						●	
	Ultraviolet	L37C	1	●	●	●	●	●	●	●	●			
For Black-and-White Film	Ultraviolet	L39	1		●							●		
	Yellow	Light	Y44	1.5 (1/2)		●							●	
		Medium	Y48	1.7 (2/3)	1.2 (1/3)	●	●	●	●	●	●		●	●
		Deep	Y52	2 (1)	1.4 (1/2)	●	●						●	
	Orange	O56	3.5 (1 5/6)	2 (1)	●	●	●	●	●	●		●	●	
	Red	R60	8 (3)	5 (2 1/3)	●	●	●	●	●	●		●	●	
	Green	Light	X0	2 (1)	1.7 (2/3)		●							
Deep		X1	5 (2 1/3)	3.5 (1 5/6)		●								
For Both Color and Black-and-White Film	Soft filters	No.1	1		●	●	●							
		No.2	1		●	●	●							
	Polarizing	Polar	2-4 (1-2)		●	●	●							
	Neutral Density	ND2X	2 (1)	●				●						
		ND4X	4 (2)	●	●			●						
		ND8X	8 (3)	●	●									
ND400X		400 (8.3)		●										
For Color Film	Amber	Light	A2	1.2 (1/3)	●	●	●	●					●	
		Deep	A12	2 (1)	●	●	●							
	Blue	Light	B2	1.2 (1/3)	●	●	●	●					●	
		Medium	B8	1.6 (2/3)	●	●								
		Deep	B12	2.2 (1 1/4)	●	●	●							

( ) indicates increase in f/stop.

# ACCESSORIES—continued

## Camera Cases

Semi-soft cases, such as the CF-27, CF-28, CF-29 and CF-28A are available. The CF-27 case accommodates the FE2 mounted with a lens smaller than the 50mm f/1.4. The CF-28 can be used with any lens from 50mm f/1.2 to 105mm f/2.5 or with the Nikon Series E 36~72mm f/3.5 lens. When the Motor Drive MD-12 is attached to the FE2, the CF-29 case is recommended. The CF-28A is a front-flap for use with all lenses up to the Nikkor 35~70mm f/3.5. The soft-type CS-16 case is also available.

## Neckstraps

Available are the leather neckstrap AN-1 (black), webbed nylon neckstraps AN-4Y (yellow) and AN-4B (black), and wider webbed nylon neckstraps AN-6Y (yellow) and AN-6W (wine-red).

## Compartment Cases

A wide selection of six types to choose from, ranging from a compact type to a large type which can accommodate large or bulky camera equipment: FB-8, FB-11A, FB-14, FB-15, FB-16 and FB-17.



CF-27



AN-6Y



AN-4Y



FB-11A

# TIPS ON BATTERY USE

- Keep batteries away from infants and small children. In case a battery is accidentally swallowed, call a doctor immediately as the material inside the batteries can cause serious problems.
- Battery power falls off in extremely cold temperatures and this may cause the camera's photometric circuit to cease operating. In this situation, use new batteries and protect the camera body from the cold. Note that battery power will be recovered as soon as the temperature becomes normal.
- Should the battery be left in the battery chamber for a long period, insufficient contact may occur due to battery leakage. Thus, it is good practice to periodically clean the battery and the contact section in the battery chamber with a soft cloth. If the battery chamber is contaminated with a leaking battery, remove the battery at once and clean the chamber.
- If you're using a pair of batteries, change them at the same time; never mix new and old batteries or batteries of different brands.
- When not using the camera for a long period, take batteries out and store them in a cool, dry place.
- Never disassemble batteries or discard them in a fire.
- Always check battery power before the shooting session because battery power can become exhausted without warning. It is a good idea to have spare batteries on hand during a lengthy shooting assignment.
- In normal use, a battery's lifespan is about one year. The battery packed with this camera, however, is for test purposes only so its lifespan may be shorter than usual.
- Regardless of whether the camera is switched off or not, the FE2 always discharges a small amount of electricity, because it incorporates a quartz oscillator circuit.

# TIPS ON CAMERA CARE

Although the FE2 is a tough and durable camera, bear in mind that it is a precision optical instrument, and that careless or rough handling may damage it. Observe the following tips, and the FE2 will always work as perfectly as the day you bought it.

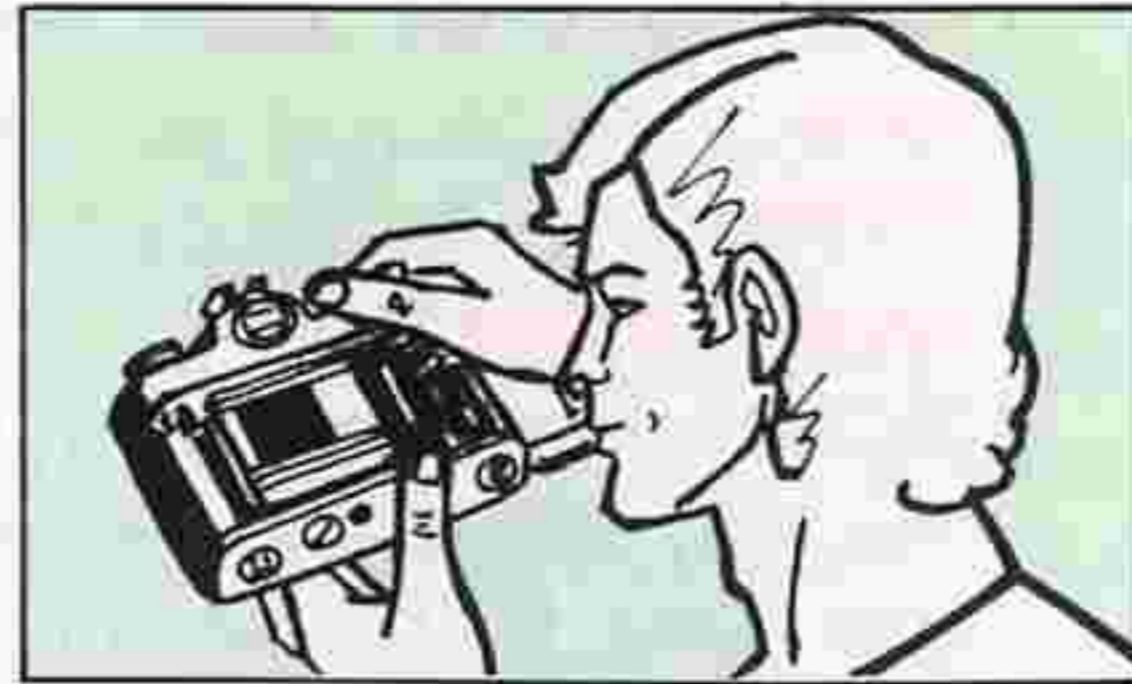

- Before using the camera, it is a good practice to check it thoroughly first.

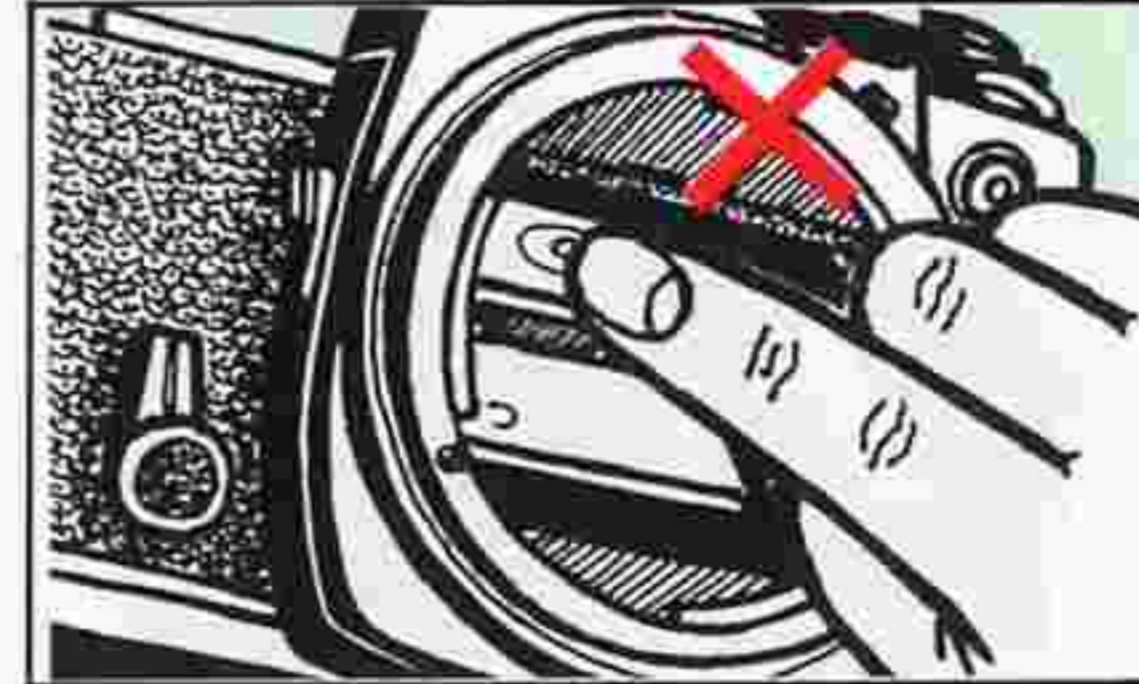

- Never touch the reflex mirror or the focusing screen, to prevent them from becoming scratched. Remove dust with a blower brush.

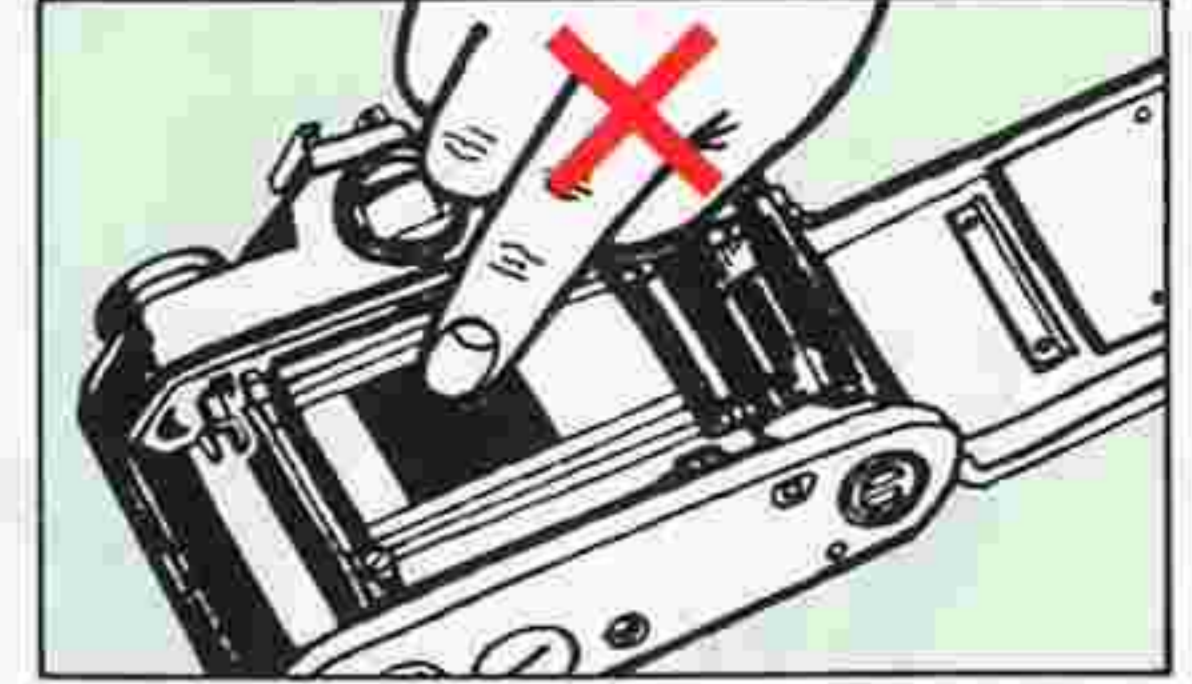

- Do not touch the shutter curtains.

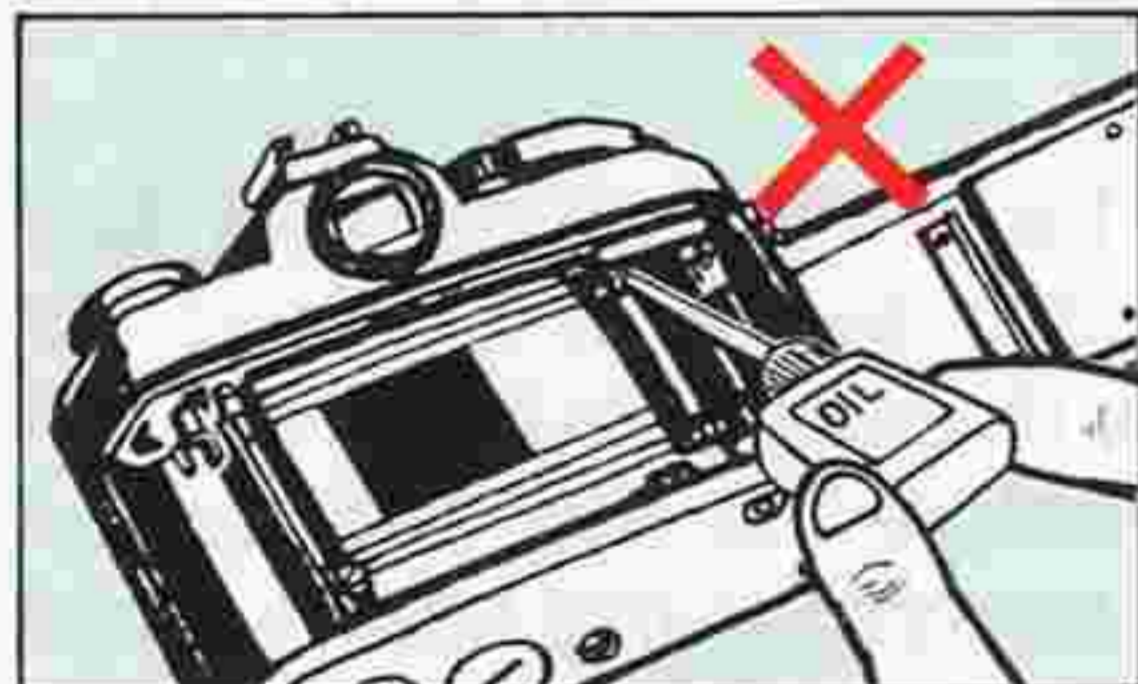

- Generally, the camera does not need lubrication.

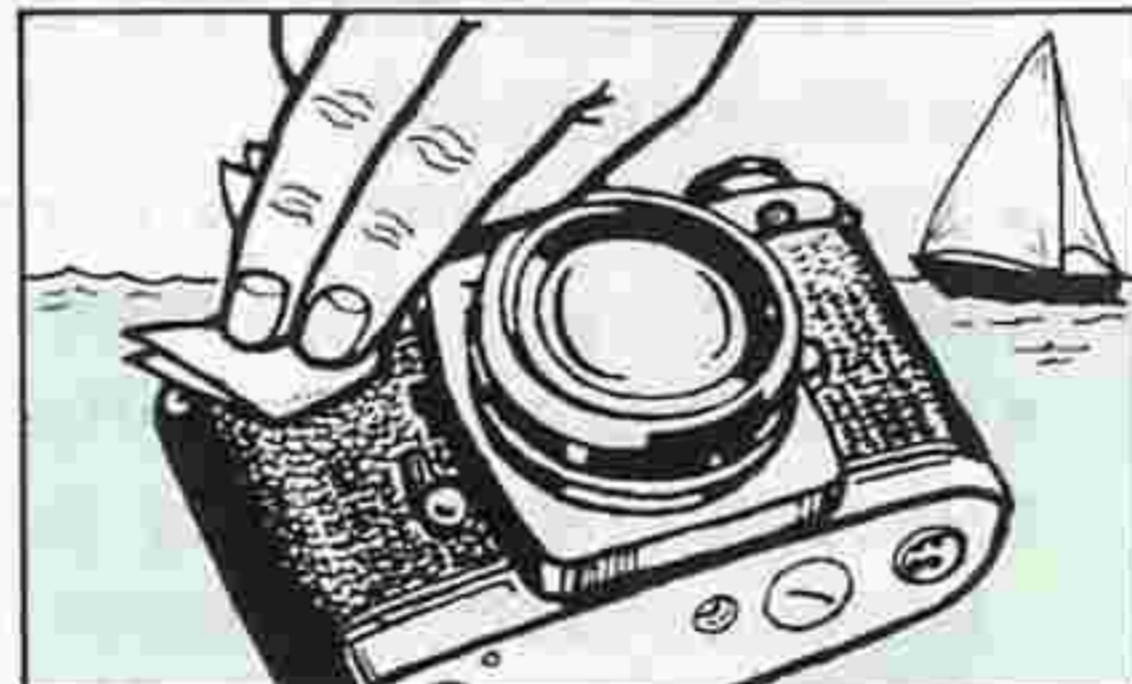

- If the camera body is exposed to rain or mist, wipe moisture gently with a soft cloth and dry the camera. After using the camera near salt water, take care that you wipe it with a cloth moistened with pure water to remove possible traces of salt.



- If the inside of the camera body accidentally gets wet, its internal precision parts may get rusty. Take the camera right away to the nearest authorized Nikon dealer for a checkup, which may require repair payment.

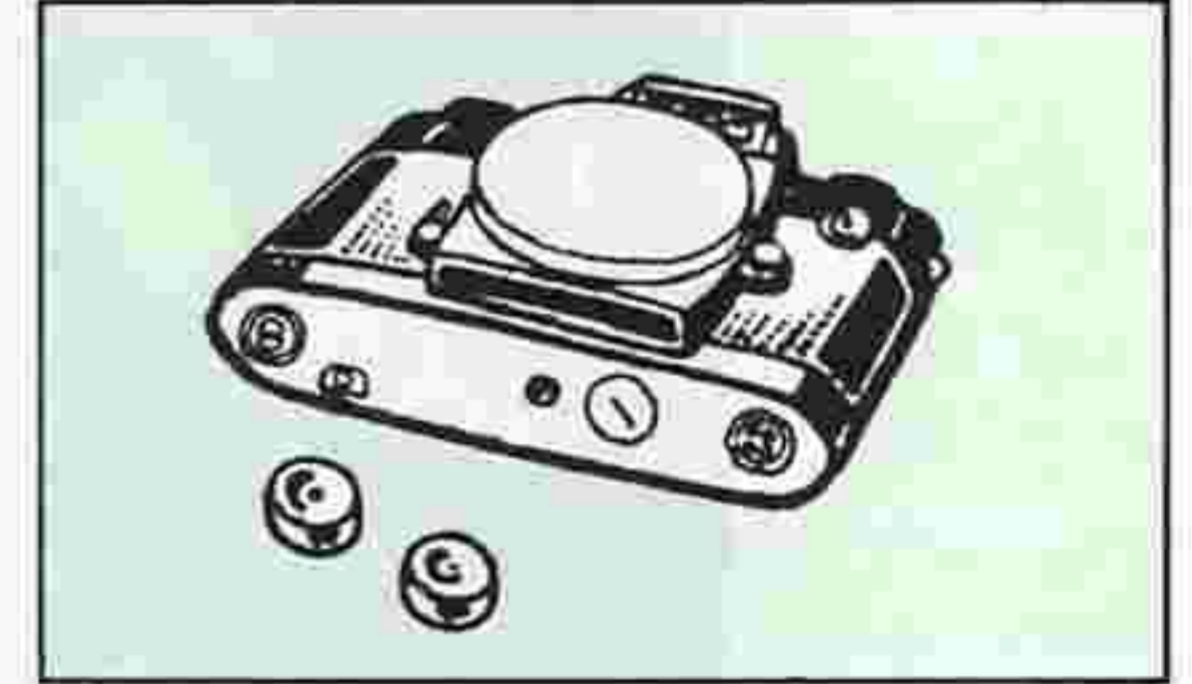

- When not using the camera for a long time, take out the batteries and store the camera away from high temperature, high humidity, naphthalene, or camphor.

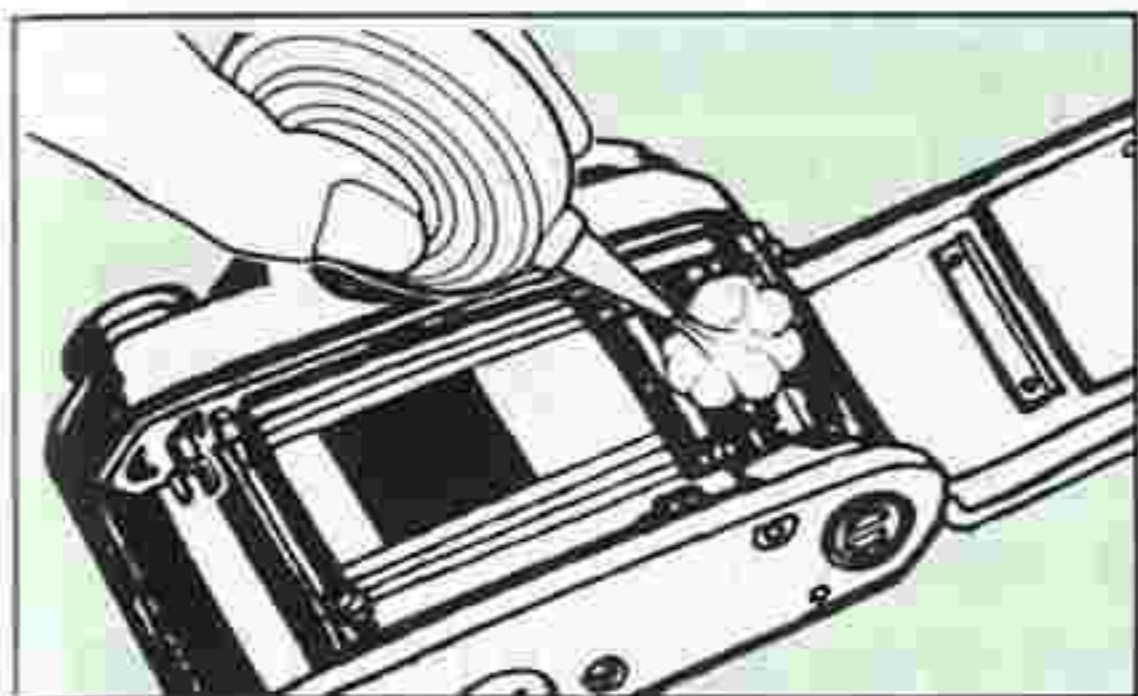

- Clean metallic parts with a blower brush or with a soft dry cloth.



- Clean glass surfaces such as the lens or the finder eyepiece with a blower brush; avoid using lens tissue as much as possible. Gently wipe dirt, smudges, or fingerprints with soft cotton moistened with a small amount of absolute alcohol, using a spiral motion from center to periphery. Make sure you leave no wiping traces.

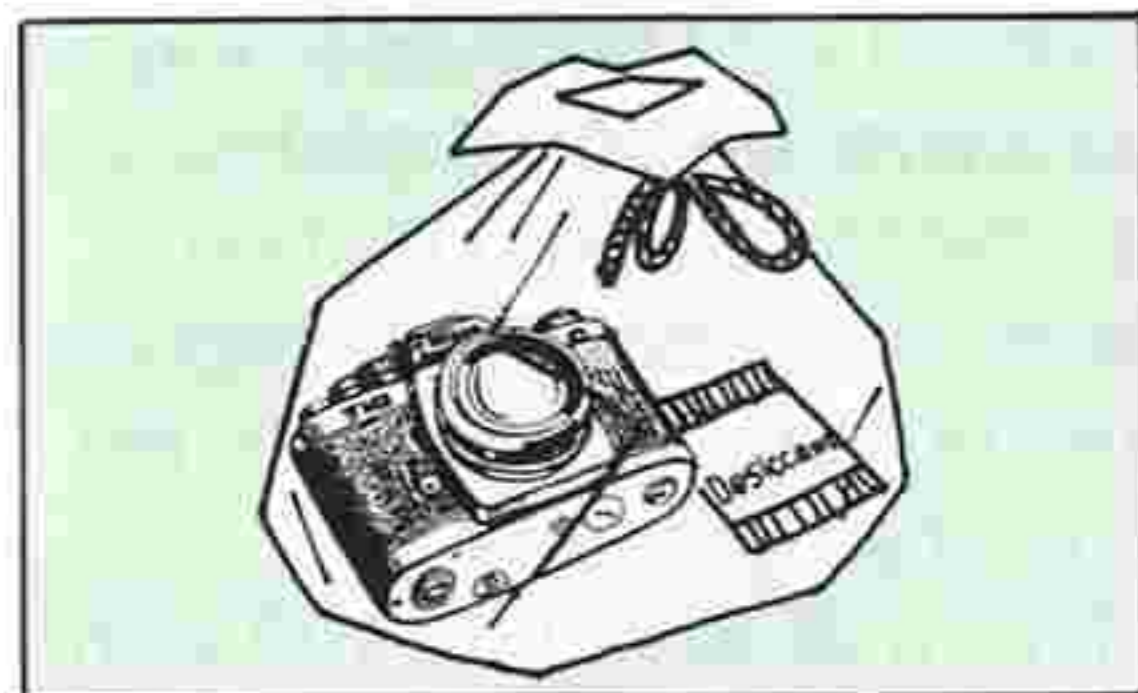

- In a humid environment, it is best to store the camera in a vinyl bag with a desiccant to keep away dust, moisture and salt.



- Note that storing leather cases in a vinyl bag may cause the leather to deteriorate, so exercise due care.

### Caution

Please note that the use of a spray-gun type blower to clean the lens may cause possible damage to the glass (especially when ED glass is used for the front lens element), by suddenly lowering the temperature on the lens surface. To avoid damage, hold the blower upright, keep its nozzle more than 30cm away from the lens surface and move the nozzle around so that the stream of air is not concentrated in one spot.

# SPECIFICATIONS

<b>Type of camera:</b>	Electronically-controlled 35 mm single-lens reflex (SLR) focal plane shutter camera	<b>Reflex mirror:</b>	Automatic instant-return mirror
<b>Usable film:</b>	Any cartridge-type 35 mm film	<b>Self-timer:</b>	Quartz-timed approx. 10 sec. delayed exposure; setting "cancellable"
<b>Picture format:</b>	24 mm × 36 mm	<b>Memory lock:</b>	Provided; via lever
<b>Lens mount:</b>	Nikon bayonet mount	<b>Multiple exposure:</b>	Provided; via lever
<b>Lens available:</b>	More than 60 interchangeable Nikkor and Nikon Series E lenses, including 50 mm standard lenses	<b>Flash synchronization:</b>	Built-in hot shoe for mounting flash unit; sync terminal also provided; M250 setting for 1/250 sec. sync
<b>Shutter:</b>	Electronically controlled vertical-travel, metal focal plane shutter with titanium curtains	<b>Ready-light:</b>	Provided inside the viewfinder
<b>Shutter speeds:</b>	Stepless speeds from 8 to 1/4000 sec. on A (Auto) mode; 16 speeds quartz-controlled from 8 to 1/4000 sec. on manual; mechanically controlled, 1/250 sec. at M250 setting and long exposure at B setting	<b>Exposure metering:</b>	Through-the-lens, center-weighted, full-aperture exposure measurement employing two silicon photo-diodes (SPD's) with Nikkor and Nikon Series E lenses fitted with meter coupling ridge; exposure correctly set either automatically or by matching two needles; meter cross-coupled with both lens diaphragm and shutter speed controls, meter powered by two 1.55V silver-oxide batteries, two 1.5V alkaline-manganese batteries or one 3V lithium battery
<b>Viewfinder:</b>	Fixed eyelevel pentaprism type; 0.86X magnification with 50 mm lens set at infinity; 93% frame coverage	<b>Metering range:</b>	EV 1 to EV 18 at ASA/ISO 100 with f/1.4 lens
<b>Viewfinder display:</b>	Shutter speed, aperture f-number, exposure compensation mark, meter needle, shutter speed needle		
<b>Focusing screen:</b>	Matte/Fresnel focusing screen with central split-image rangefinder spot and microprism collar (Nikon Type K2 screen); two other types of screens available optionally (Type B2 and E2)		

<b>Exposure compensation dial:</b>	Provided; $\pm 2$ EV in one-third increments
<b>Film speed range:</b>	ASA/ISO 12 to ASA/ISO 4000
<b>Film winding:</b>	Via single-stroke lever with 135° winding angle and 30° standoff angle; lever also serves as shutter release lock; automatic film winding possible using the optional Motor Drive Unit MD-12
<b>Frame counter:</b>	Additive type; automatically resets to “S,” three frames before “1,” when camera back is opened
<b>Film rewind:</b>	By crank after film rewind button is depressed
<b>Depth-of-field preview:</b>	Via lever provided on front of camera
<b>Camera back:</b>	Hinged, swing-open type; removable; memo holder provided
<b>Tripod socket:</b>	1/4 inch
<b>Dimensions (body only):</b>	Approx. 142.5mm(W)×90.0mm(H)×57.5mm(D)
<b>Weight (body only):</b>	Approx. 550g

Specifications are subject to change without notice.



No reproduction in any form of this booklet,  
in whole or in part (except for brief quotation in  
critical articles or reviews), may be made without  
written authorization from Nippon Kogaku K.K.

**NIPPON KOGAKU K.K.**

Fuji Bldg., 2-3, Marunouchi 3-chome, Chiyoda-ku, Tokyo 100, Japan  
**Phone:** 81-3-214-5311 **Telex:** J22601 (NIKON) **Fax:** 81-3-201-5856

Printed in Japan 8&127-A001